







Track and Encapsulation Options

<p>Gunite Encapsulation X1651 New 2018</p> 	<p>Fiberglass Encapsulation X1953 New 2018</p> 	<p>Vinyl Liner Encapsulation X1650 New 2018</p> 
<p>Gunite Encapsulation Cantilever X0410 New 2018</p> 	<p>Vinyl Liner Raised Encapsulation X0420 New 2018</p> 	<p>Clip-on Rounded Coping X0804</p> 
<p>Reusable Coping Forms X0743 & X0719</p> 	<p>Reusable Coping Form w/ Spacer X0719 & X0815</p> 	<p>2-Piece Deck Form Kit X0693 & M9648 & X0815 & X0691</p> 
<p>Coping Inclined X0958</p> 	<p>Coping Rounded X0955</p> 	<p>Coping Bullnose X0947</p> 
<p>Top Track & Under Track X0656 & X0820</p> 	<p>Slim Flush Track Kit A0021</p> 	<p>Recessed Horizontal Track Kit A2123</p> 

Pool Cover Terminology

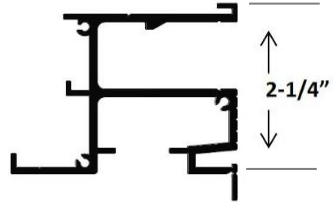
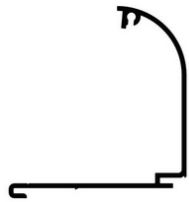
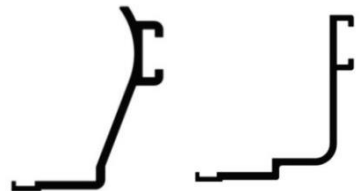
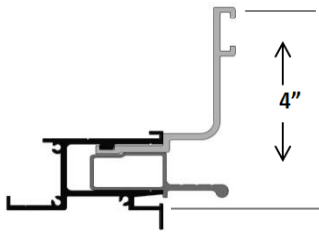
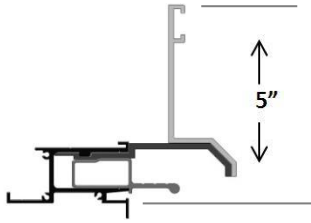
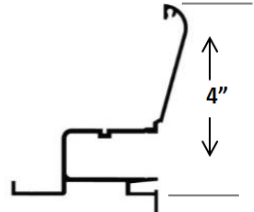
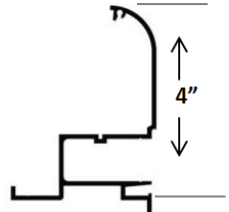
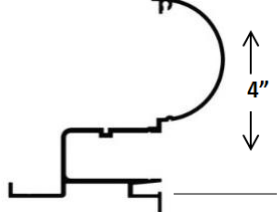
Gunite Encapsulation

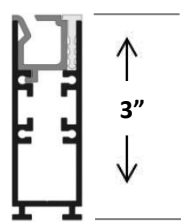
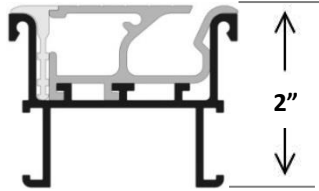

Vinyl Liner Encapsulation

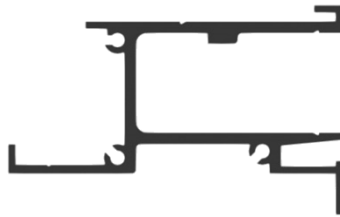

Fiberglass Encapsulation

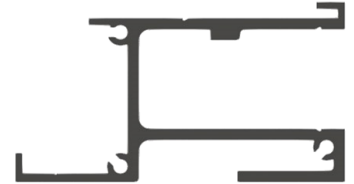

Under Track



Reusable Coping Forms

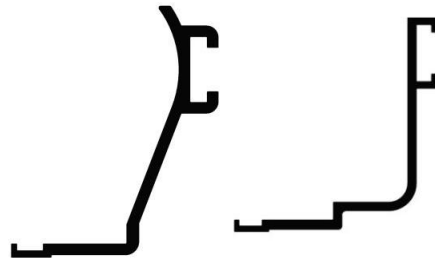

Clip-on Rounded Coping

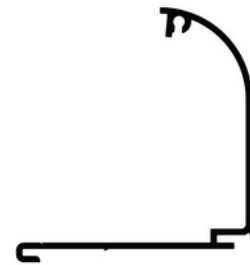

Bullnose Coping

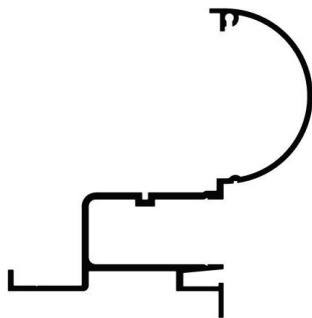

Rounded Coping

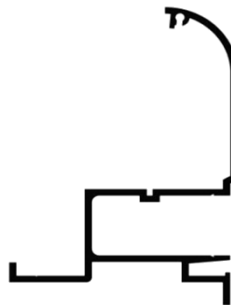

Inclined Coping

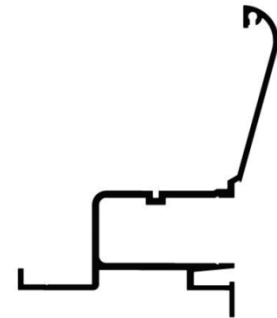

Under Track Guide



Under Track Pulley



1 Inch Pulley



Top Track



Top Track End Pulley



Top Track Speed Guide



Top Track Stop



Top Track Splice Kit



Top Track Wheel Assembly

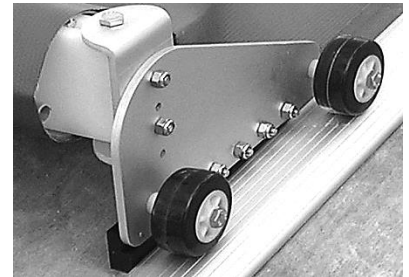

Top Track Wheel Assembly For 2-1/2" Leading Edge

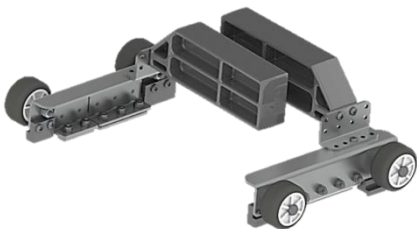

Top Track Wheel Assembly For 1" Leading Edge



Deck Mount Plastic Housings



Recessed Horizontal Track

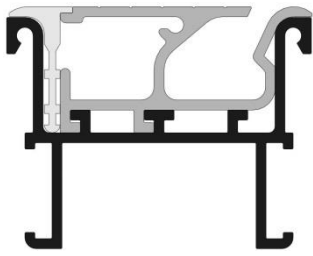

Recessed Horizontal End Pulley

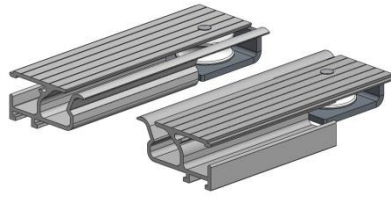

Recessed Horizontal Guide Feed



Slim Flush Track

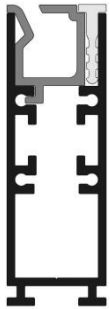

Slim Flush End Pulley

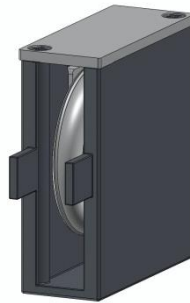

Slim Flush Guide Feed



Walk-on Tray Lid Aluminum



Walk-on Tray Lid Bracket SS



Walk-on Lid Bracket Aluminum

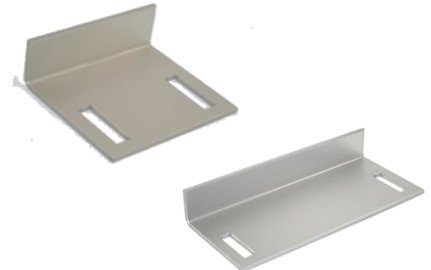

Lid Bracket for Riser Panel



Standard UT & TT Lid Bracket

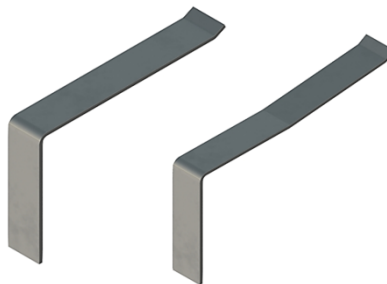

Two Piece Aluminum Lid Bracket



Touch Pad



Key Switch



Rotary Encoder Limit Switch

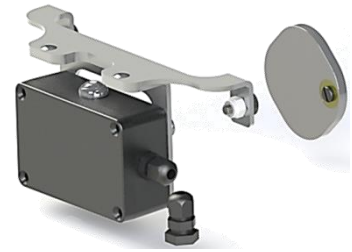

Eclipse Torque Limiter

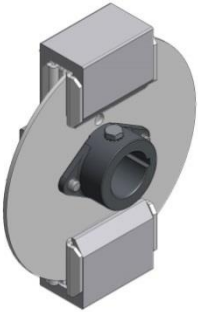

Eclipse Mechanism Deck Mount

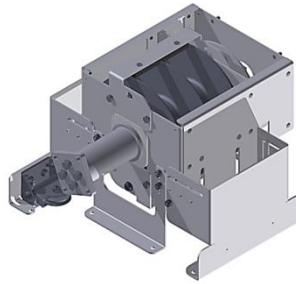

Eclipse NME Deck Mount

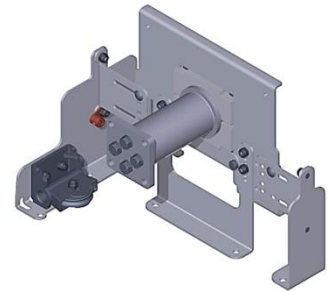

Eclipse Mechanism Recessed

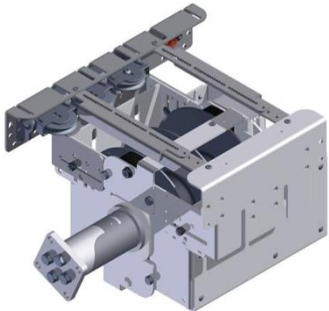

Eclipse NME Recessed

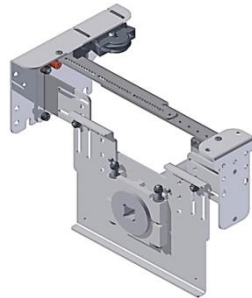

Rope Reel

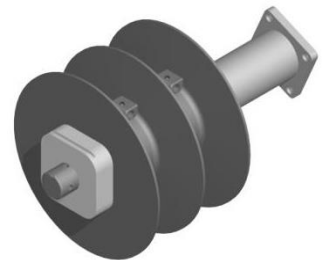

Eclipse NME Pulley Bracket Assembly

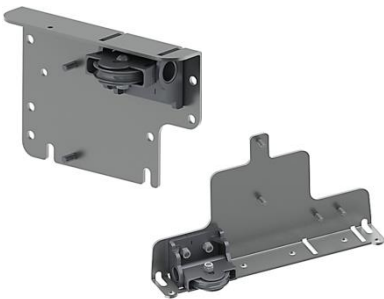

Eclipse ME Pulley Bracket Assembly



Vanishing Edge Assembly

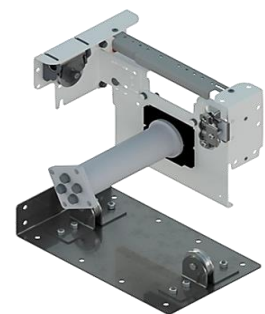

Rope Reel Brake Assembly



Eclipse NME Cone & Brake Assembly

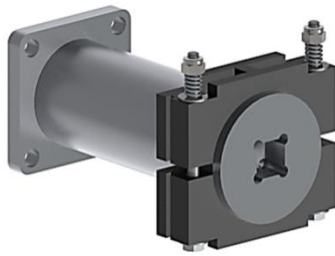

Roll-up Tube Insert



Feature Control

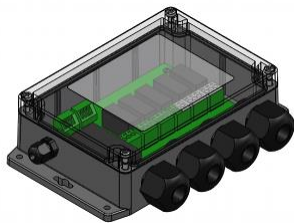

3 Wire Motor



3 Wire Limit Control & Sensor



Latham AC Motor

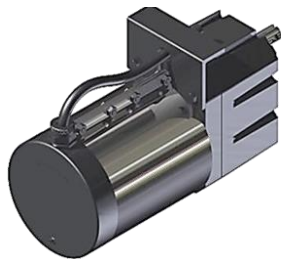

3 Wire Bison Motor

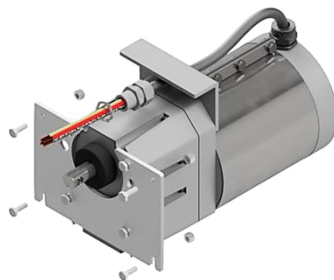

Electric Motor Smart Control Board



Hydraulic Hose with Fittings



Hydraulic Pump & Power Pack



Hydraulic Motor Coupler



Eclipse Cone ME & NME



CS300HD Motor

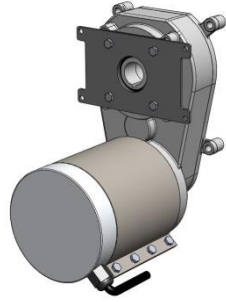

CS300HD Cone

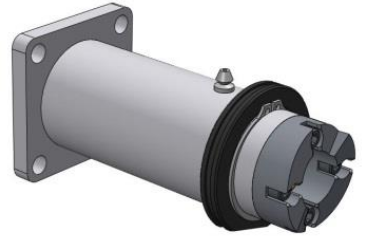

CS300HD Opposite End

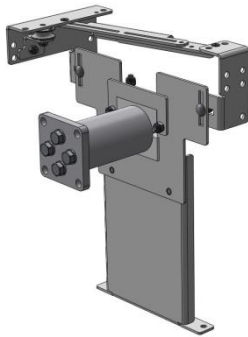

CS300HD Mechanism

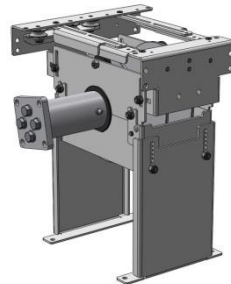

CS300HD Shaft w/ Double Dog

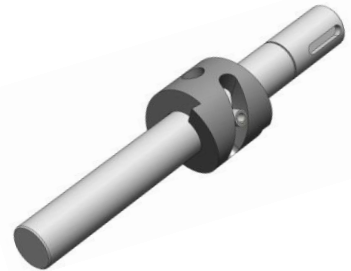

CS300HD Rope Reel

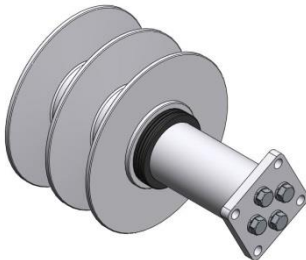

Vanishing Edge



Stone Lids and Vanishing Edge



Concrete Walk-on Tray Lids



Extreme Cantilever



Double System



Recessed Top Track with Deck Drag



2 Foot Radius Corner With Flush Lid



6 Inch Radius Corner



Recessed Flush Track with Aluminum Lid



Flat Lid



Aluminum Bench

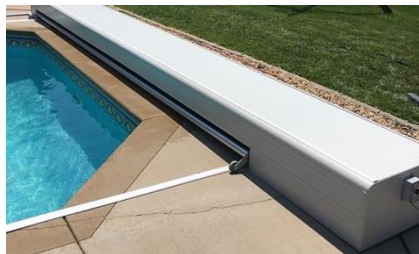

Plastic Housing

