

Let the Coverstar team keep your family safe!

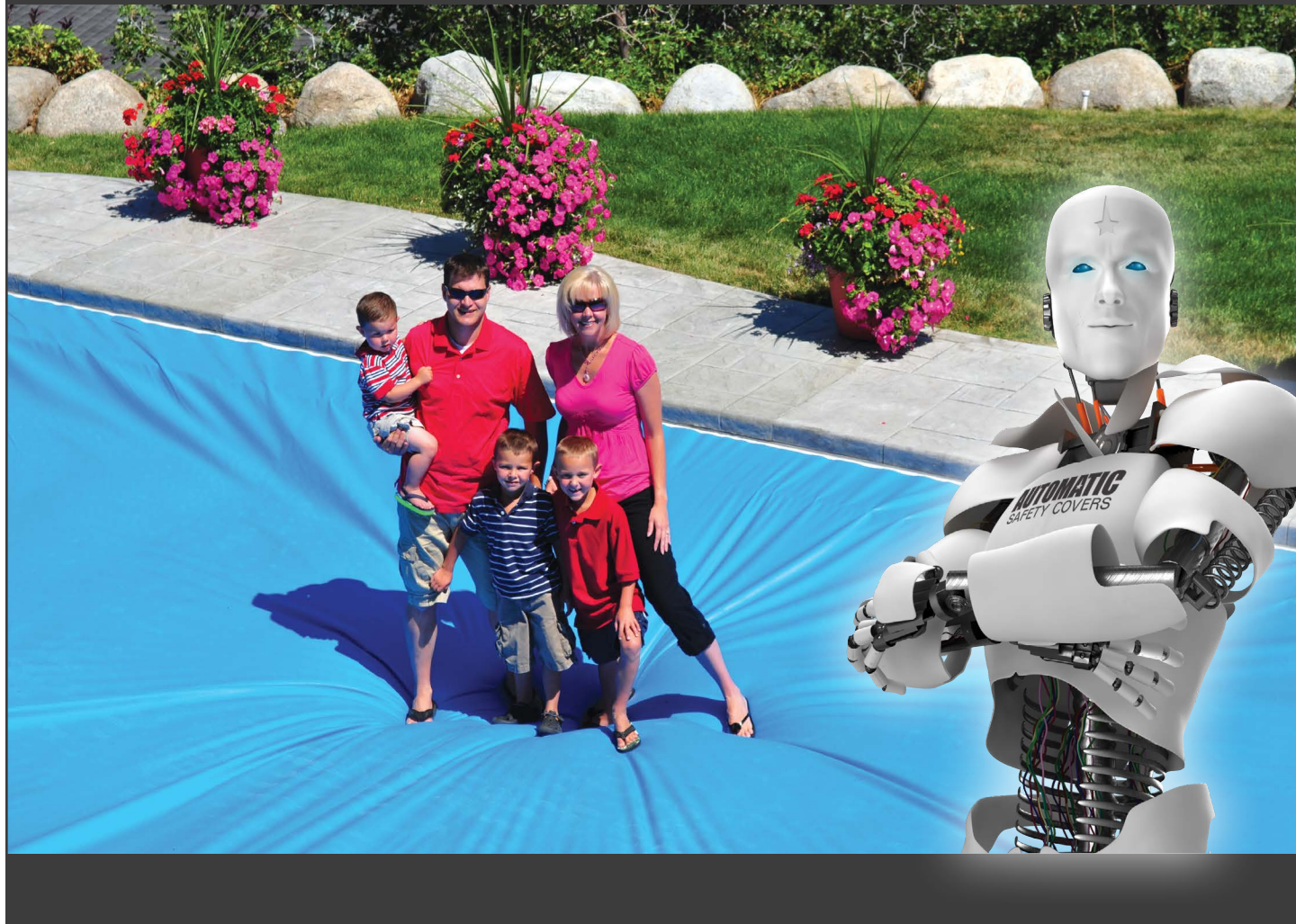

We make it strong. We make it easy.™
COVERSTAR®

To find out more about Coverstar ultimate quality Automatic, Solid, and Mesh Safety Swimming Pool Covers, please visit coverstar.com or call 800-617-7283.



latham

787 Watervliet Shaker Road • Latham, New York 12110 • 1-800-833-3800
 383 Elgin St., Brantford, Ontario N3S 7P5 Canada • 800-638-7422



© Latham Pool Products, Inc. 20120. All rights reserved.

L0021.20 3/20

We make it strong. We make it easy.™
COVERSTAR®

A Photo Guide to Automatic Cover Options FOR CONCRETE/SCREW-ON POOLS



latham



CONCRETE AND GUNITE PHOTO GUIDE

TABLE OF CONTENTS

Under Track Applications 1	General Options 17
Encapsulation and Track Options 2	Mechanism 17
Coping Options 3	Switch 18
Cover Housing Lid Options 5	Leading Edge 18
Pool-In-Pool Applications 10	Fabric Colors 18
	Upgrades and Add Ons 19
Top Track Application 11	Motor Side and Switch Location 21
Track Options 12	Housing Drainage 22
Cover Housing Lid Options 13	General Options
Deck Mount Housing Options 15	Exterior Spas 23
	Interior Spas 24
	Raised Walls 25
	Vanishing Edge 27



Under Track Application Options

Under track autocovers provide the most integrated and seamless look for your pool. Both the tracks and the mechanism that move the cover are located below the deck and coping.

Track Options

Tracks are attached to the two long sides of the pool. They have channels that the cover fabric slides through holding it to the edges of the pool. There are two ways to attach the tracks to the pool. Though the coping options are limitless when using the encapsulated track, coping will need to be at least 2" thick with Screw-On Tracks and Stone Walk-On Lid options.

Screw-On Tracks

Tracks are attached by drilling holes in the underside of the coping every two feet, inserting a plastic anchor, then screwing into the anchor. This method relies on the strength of the connection between the anchor and the coping, the coping itself, and the bond between the coping and the pool wall. Coping must be two inches thick and overhang the pool tile two and one-half inches. It is best to use coping that is at least 14" wide.

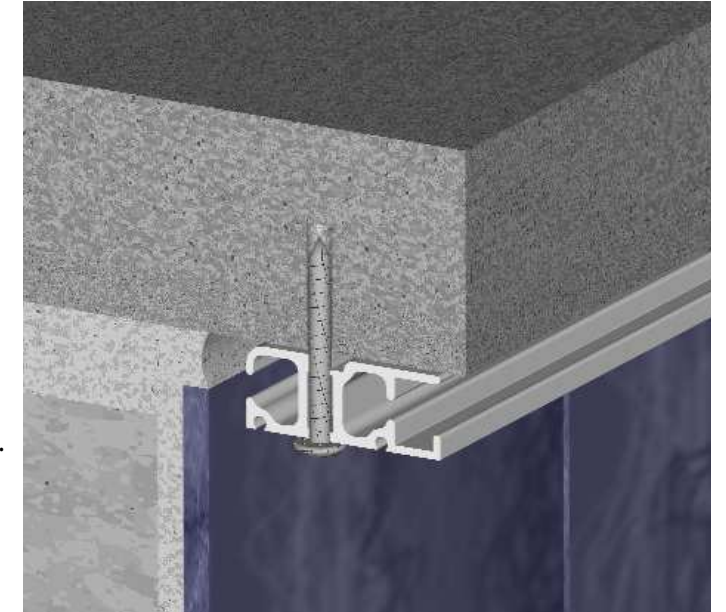

Under Track versus Top Track/RHT

Under track is used in the following applications: Standard & Encapsulated Under track, Pool-in-Pool, and Extreme Cantilever. It uses a slider and Leading Edge Bar insert to support the Leading Edge Bar directly to the side of the track. This typically makes the Leading Edge Bar at or below the deck surface. Under track catches less dirt and needs less cleaning. There are many different encapsulations configurations to allow it to be used with a variety of pool types.

Top track, Recessed Horizontal Track, and Screw Down Recessed Horizontal track are all used to cover existing pools or free form pools and rectangles with free form elements (outside benches and walk-out steps). These use a wheel assembly to support the Leading Edge Bar above the deck. This can make the Leading Edge Bar almost 7" above the deck. These tracks capture much of the debris on the deck surface and should be cleaned often.

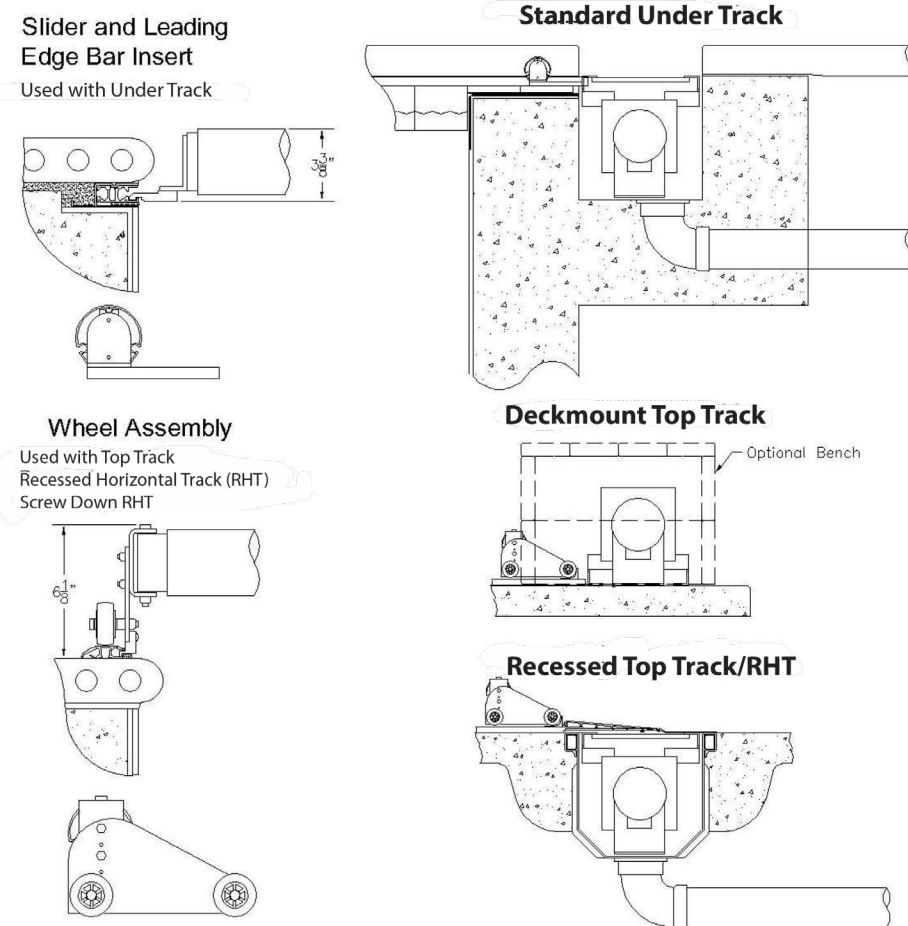

Tracks: Encapsulated Track

Tracks are contained in a sleeve called "encapsulation" in the pool wall. Encapsulation is attached to the top of the pool wall after the tile has been put on, then the coping is placed on top of the encapsulation. This method does not depend on the coping for strength, but instead on the encapsulation that is screwed and cemented into the pool wall. Coping overhang is typically one half inch and the coping is usually 12" wide. Coping can be any thickness. Cantilever deck forms that clip into the encapsulation are also available for forming the edge of the concrete deck along the inside of the pool.



Coping Options

Even though coping options are limitless when using the encapsulated track, coping will need to be at least two inches thick with Screw-On Track and Walk-On Lid options. For matching Walk-On Lid stones, choose coping that is at least two inches thick, at least 14" wide, and 16" to 48" long.

Coping: Natural and Pre-cast Coping Stone



Bluestone with Screw-On Track



Bluestone with Encapsulated Track



Limestone with Screw-On Track



Travertine with Encapsulated Track



Flat Pre-Cast Stone Coping



Brick Coping with Encapsulated Track

Coping: Formed Cantilevered Concrete

Standard cantilever and inclined forming profiles are available for encapsulated track posts.

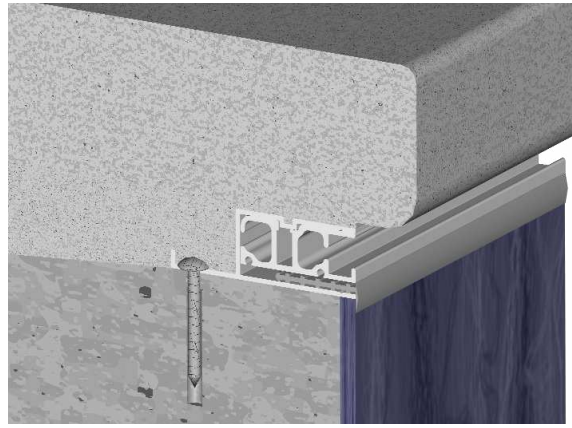

Standard Cantilever Forming

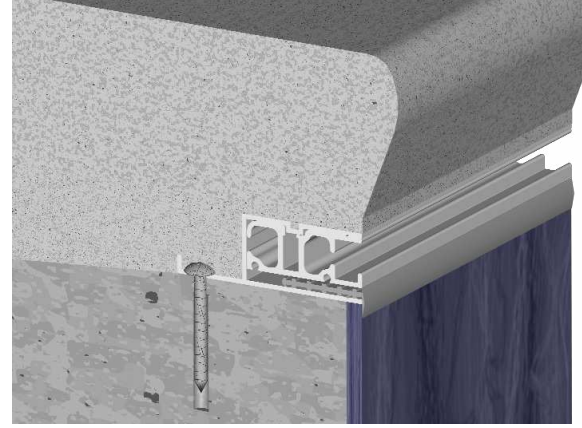

Inclined Forming



Exposed Aggregate Concrete



Brushed Concrete



Stamped Concrete



Stamped Concrete

Cover Housing Lid Options

The cover box lid covers the opening in the deck where the mechanism rolls up the cover. Not all lids can support the weight of people walking on the lid. The most basic lid is the Standard Aluminum Lid. The premium aluminum lids are the Flat Aluminum Lid and the Flush Aluminum Lid, and both of these lids can be upgraded to walk-on lids. Stone Walk-On Lids use coping or decking material in conjunction with our Walk-On Lid Bracket System for the most visually appealing cover box lid.

Lids: Standard Aluminum Lid

The Standard Aluminum Lid is a bright anodized aluminum lid that is screwed to the top of the deck. It is supported by brackets every four to five feet. These brackets are designed to support the lid only and cannot support the weight of a person walking on the lid. This is an economic choice best suited to pools that will not have a lot of foot traffic at the cover box end of the pool.



Lids: Flat Aluminum Lid

The Flat Aluminum Lid is a light grey painted aluminum lid that is screwed to the top of the deck with countersunk screws. It has a round bezel that wraps around the lid, and has an extended hinge range to allow easy access to the cover box. It is supported by brackets every four to five feet. The standard brackets are designed to support the lid only and cannot support the weight of a person walking on the lid. Request walk-on lid brackets to make this a walk-on aluminum lid.

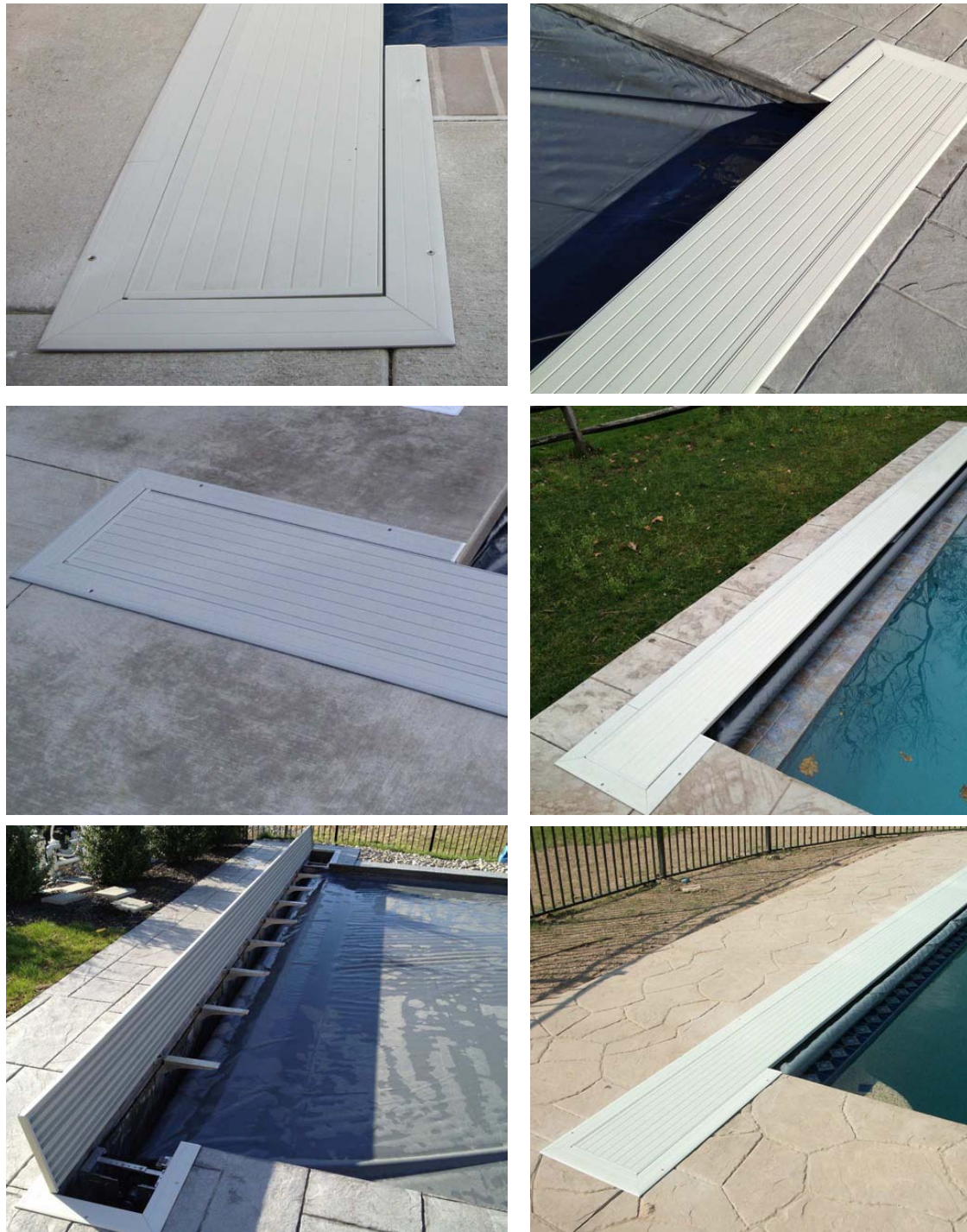

Lids: Flush Aluminum Lid

The Flush Aluminum Lid is a light grey painted aluminum lid that rests in a narrow frame which is flush with the top of the deck. This lid can only be used with concrete deck pools and is held in place by the concrete. The lid brackets clip into the frame with standard spacing every four to five feet.

The flush lid brackets support the lid only at standard spacing and cannot support the weight of a person walking on the lid. Request additional lid brackets for two foot spacing to make this a walk-on lid.



Lids: Walk-On Stone Lid

Walk-On Stone Lids use a series of brackets to support coping or deck material over the cover box where the cover rolls up. This material is typically the same as the coping material used. The lid material cannot be thicker than the coping used, but must be thick enough to support people on the lid between the brackets without breaking (typically 2 inches thick for stone). The lid material must be at least 14 inches wide to fill the cover box opening.

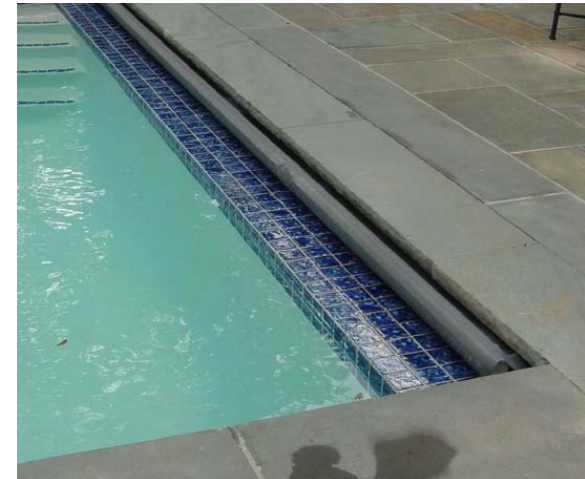
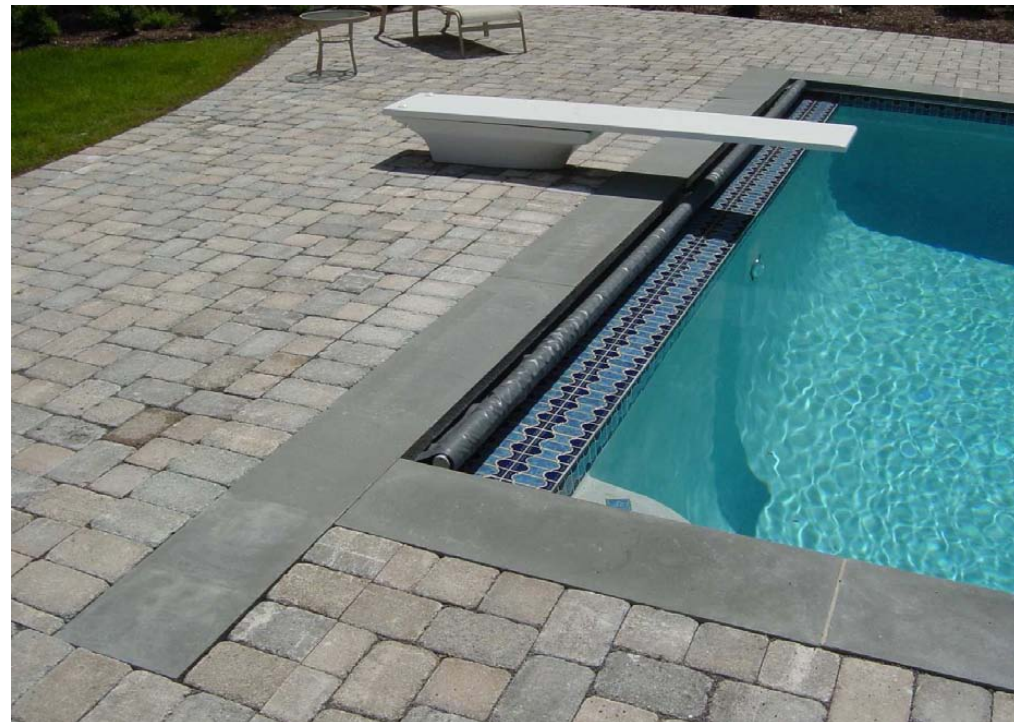

Matching Coping Stone Lid



Wood Decking Lid



Matching Coping Stone Lid

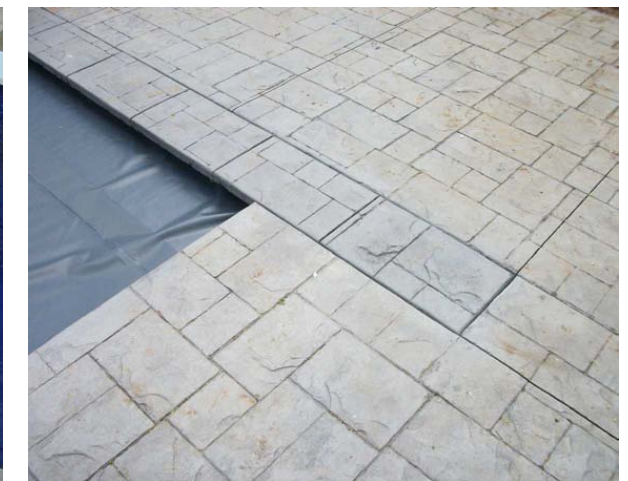

Formed Concrete Stone Lid



Non-Matching Stone



Brick Tray Assemblies

Pool-In-Pool Application

Pool-In-Pool is a hybrid of the under track and top track applications. It allows the flexibility of free form pool design while retaining the advantages of an under track system. It uses all the coping and lid options available to under track systems. The same pool shape and size considerations explained in the Top Track Application section apply to Pool-In-Pool designs.



Top Track Application Options

Top Track Autocovers provide the most flexibility for new freeform pools and existing pools. Though the pool may be any shape, the cover is still rectangular and requires tracks on either side to pull the cover over the deck and pool and secure it. Some pool shapes will require very large cover to fully cover the pool. Increasing the size, particularly increasing the width past 25 feet, increases the cost of the cover. The amount of deck required around the pool also increases. Pools that do not fill the area of the rectangular cover will have more "deck drag."

Deck drag is when the cover must be dragged across the deck instead of gliding on the surface of the pool water. When a large area of the deck must be covered, it is best to keep the pool shape within a 20' x 44' rectangle.

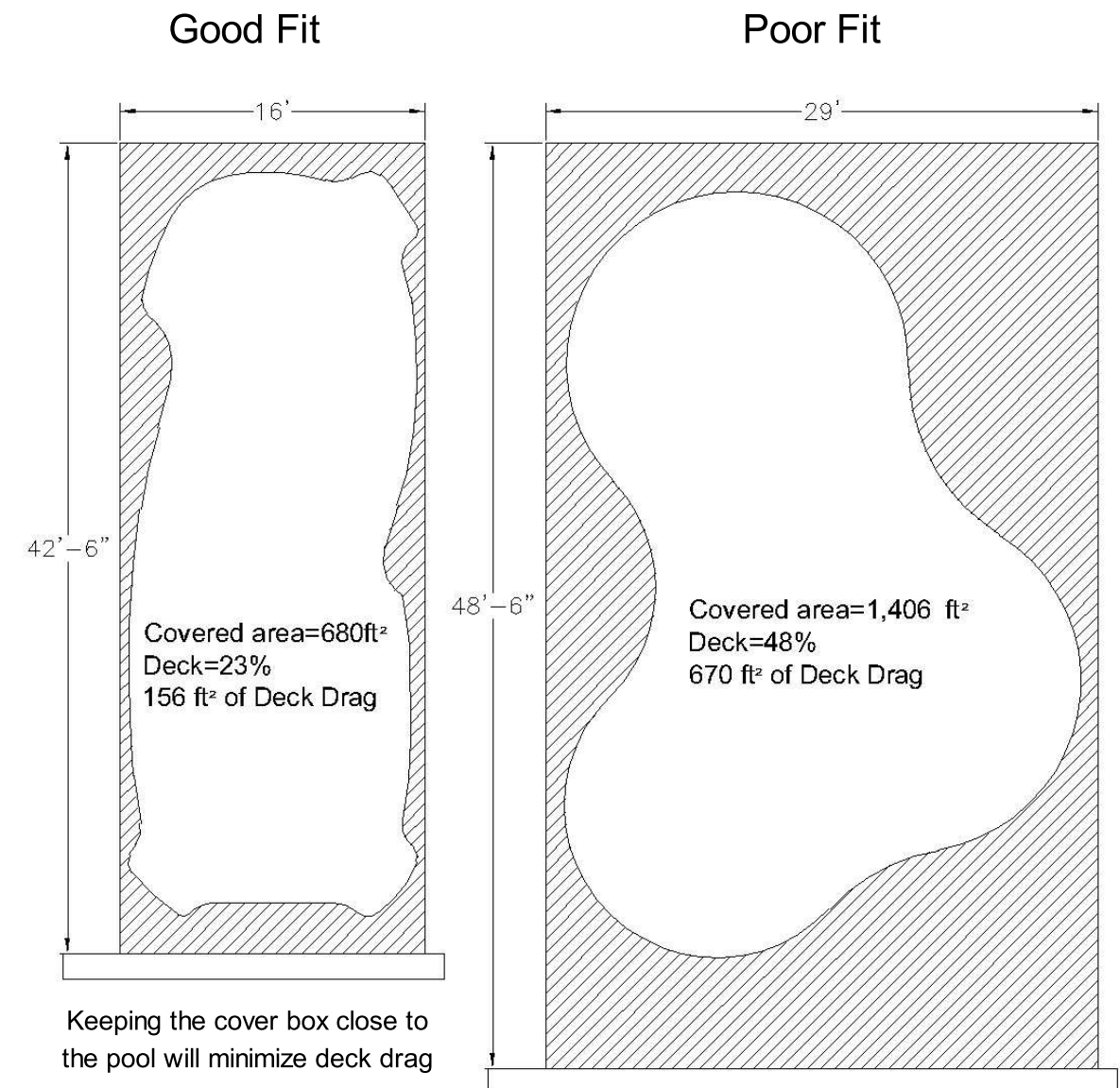

Track Options



Standard Top Track

The standard top track should not be used on dry laid pavers. Anodized Aluminum



Recessed Horizontal Top Track

The recessed top track cannot be used with dry laid paver decks. It must be secured with a concrete deck or cemented deck stone. Available in Tan or Grey



Recessed Horizontal Track Screw Down

The recessed horizontal track screw down cannot be used with dry laid paver decks. It requires a channel cut or formed-in deck. Anodized Aluminum



Vertical Slim Flush Track

The vertical slim flush track cannot be used with dry laid paver decks. It must be secured with a concrete deck or cemented deck stone. Paint Grey

Recessed Top Track Cover Housing Lid Options

Recessed top tracks have cover tracks on top of, or embedded flush with the deck, and a mechanism that is recessed below the deck. The opening for the cover is created by either elevating the front of the lid or by sloping the deck down below the front of the lid.



**Raised Lid
(Standard)**



**Sloped
Deck**

**Recessed Top Track Cover
Housing Lid Options
(continued)**

**Standard
Aluminum Lid**

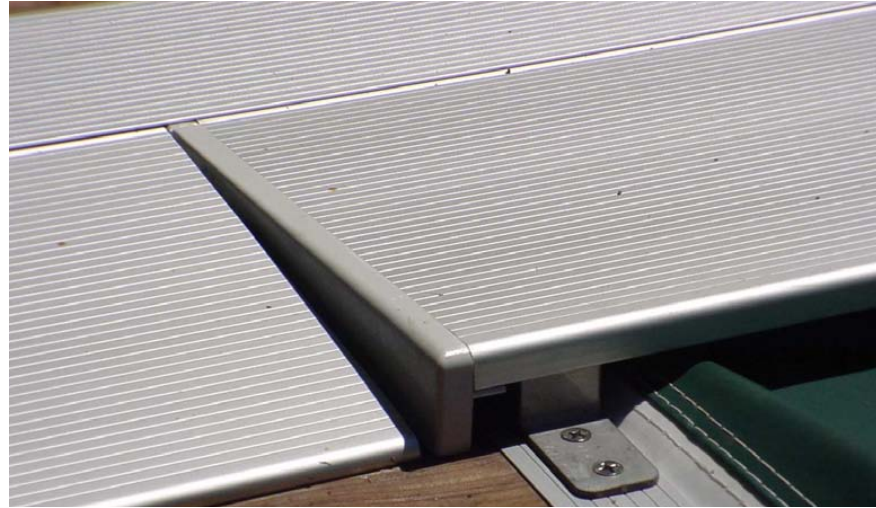

Flat Aluminum Lid

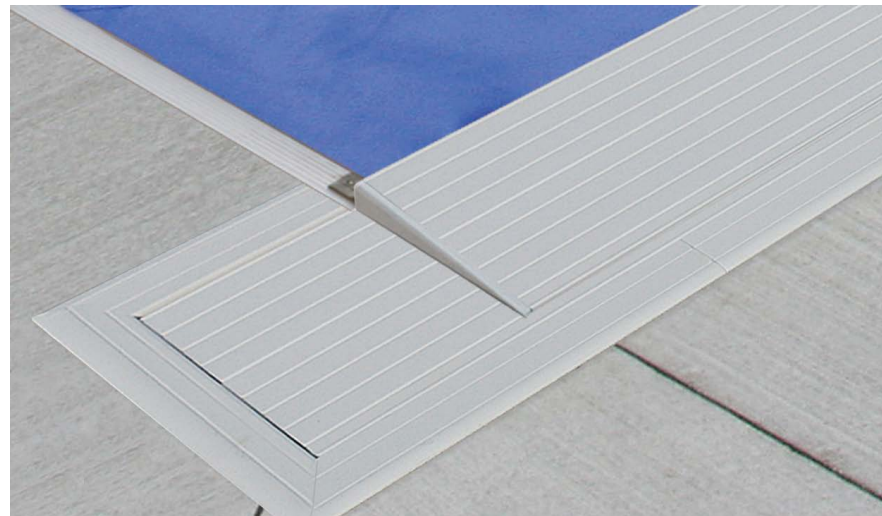

Flush Aluminum Lid



Deck Mount Top Track Housing Options

Deck mount top tracks have cover tracks on top of the deck and a mechanism that is also on top of the deck. This is an economical choice for existing pools. Mechanism End Housings are available to cover the end of the system or a bench may be built to house the entire system. Neither the system or the brackets for the bench can be anchored to dry laid pavers. They must be bolted to a concrete or cemented paver/stone deck.

No Housings



Plastic End Housings





Aluminum Bench Housing



Finished Redwood Bench Housing



Synthetic Wood Bench Housing



Unfinished Pressure Treated Wood Bench

GENERAL OPTIONS – MECHANISM MODELS

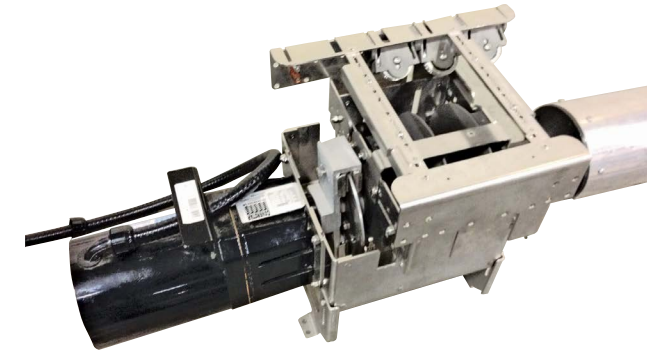

Eclipse

Built with stainless steel for the highest protection for corrosion.

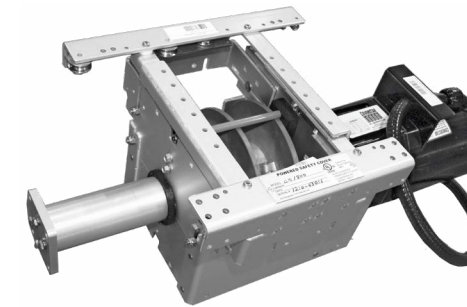

CS3000

Built with the industry standard anodized aluminum for corrosion resistance.

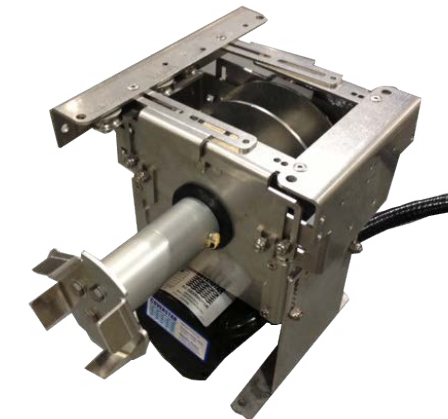

CS300-HD

Built with stainless steel, this mechanism used over/under stacked motor and reel to reduce space required for the mechanism.

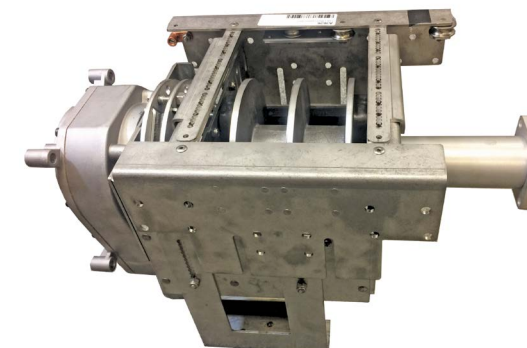

Introduced in 2018

Built with a corrosion-resistant stainless steel mechanism and featuring a tuck under clutch-driven motor.

CONTROL SWITCHES



Standard Toggle

Not available for CS300-HD Spa.



Touch Pad



WiFi Touch Pad

WiFi connection for cover status email/text alerts.



Rocker Switch

LEADING EDGE

Loop Leading Edge



Rope Leading Edge

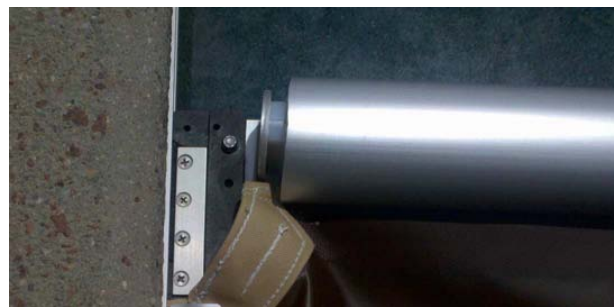

STANDARD COVER FABRIC COLORS



ADDITIONAL UPGRADES AND ADD-ONS

Hidden Leading Edge Bar

The Hidden Leading Edge Bar feature up uses extended brackets and wider lid material to extend the Walk-On Stone Lid past the Leading Edge Bar in its retracted position. This setup requires a notched lowered end wall for the leading edge bar to fit under the lid. Skimmers and interior spa walls must be lowered for additional clearance.

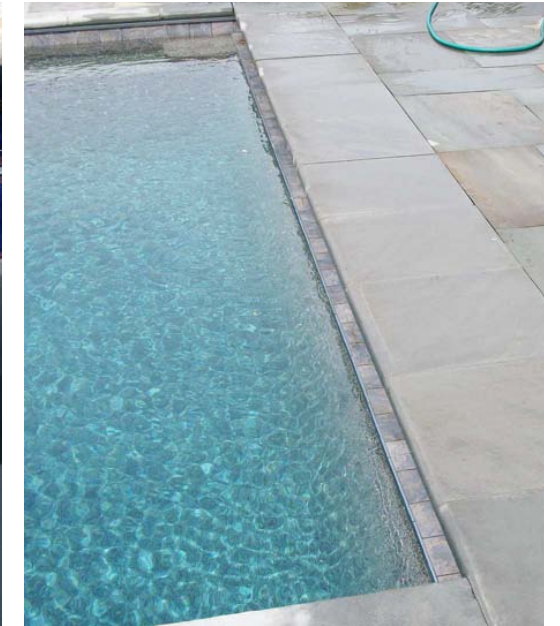

Water Feature Shut-Off Controller

Water features can pump water from the pool onto the top of the cover resulting in damage to the cover system. Using a controller can ensure that damage never happens.

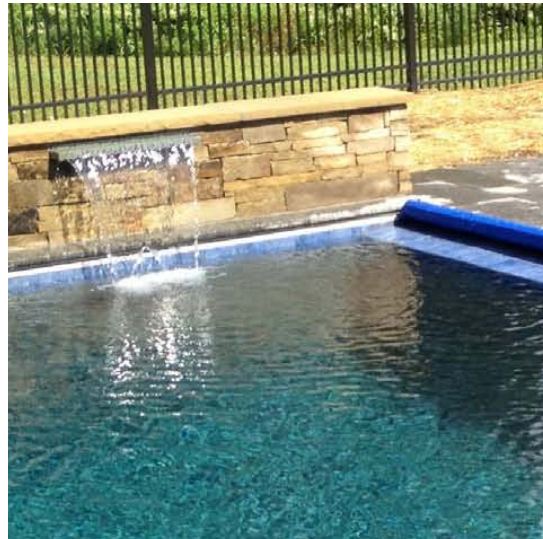

Low Voltage Rotary Limit

Used for controlling relays to water feature pumps and valves.



Extruded Roll-Up Tube

The roll-up tube is in constant contact with the cover and the water from the pool. The extruded anodized roll-up tube offers the best corrosion resistance and is recommended for salt and chlorine generator pools. Available in 6 inch and 4.7 inch.



Brick Trays

Brick trays provide a surface to which a mason may mortar bricks or pavers to, allowing this decking material to be used with the walk-on lid bracket system.

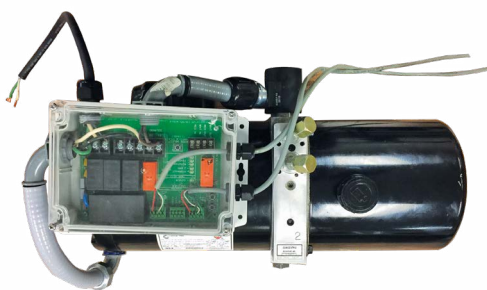

Hydraulic Power

Large heavy covers or other design consideration may require a hydraulic pump and motor to drive the Autocover mechanism.

Motor Side

Motor side is indicated as either "Left" or "Right" and is determined by standing directly behind the cover housing and facing the pool. The housing for the autocover mechanism extends 36 inches from the water's edge of the pool on the motor side and 12 inches on the non-motor side. For many autocover systems, primary considerations for choosing the motor side will be the layout of the deck, pool entry, and exit points, and expected foot traffic. Deckmount mechanisms and recessed mechanisms with aluminum lids should have foot traffic directed away from the motor side. Autocover systems with stone walk-on lids are not affected by foot traffic and so deck layout, property line easements, and electrical routing is usually considered.

Switch Location

Safety and reliability need to be the primary factors for choosing a switch location. The switch should be in a convenient location to facilitate regular use, but not at the expense of safety. The switch must be located where the entire surface of the pool is visible to the operator. The operator should visually verify the autocover is in proper working order before operating it. This is done best when the switch is located near the cover housing end of the pool. It is recommended that the switch be no more than 30 feet from the pool. The switch should never be located inside the home or other building unless it is an indoor pool, then the switch must be in the same room. See diagram below for switch location guidance.

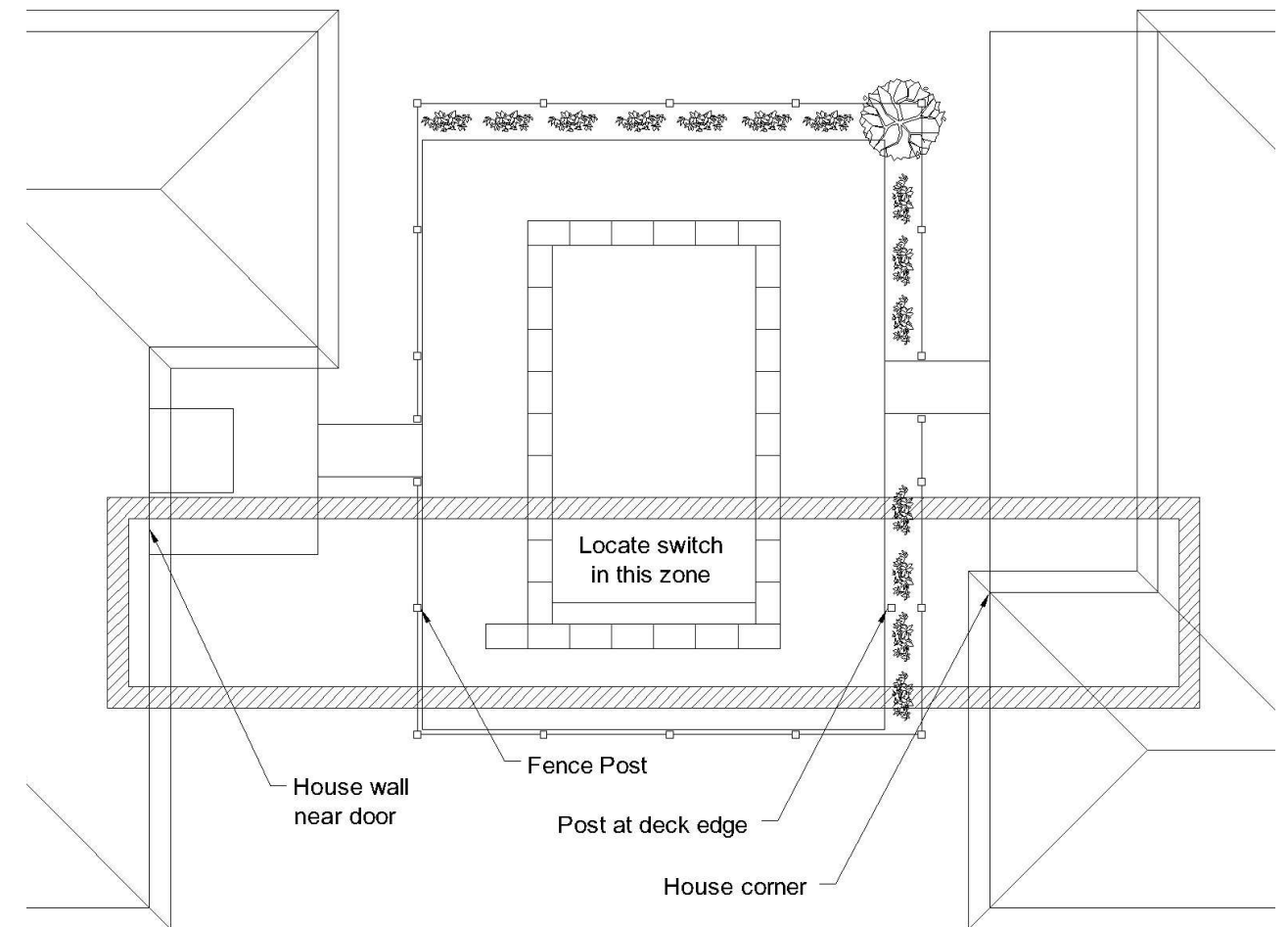

Cover Housing Drain

Under Track and Recessed Top Track systems have motorized mechanisms in cover housing below the surface of the deck that must not be flooded. Cover housing drainage should be considered in the planning stages of the pool project to ensure it is done correctly and works with the landscaping. The most reliable drain method is the drain to “daylight” or “open air”. If the site topography has no significant slope, the finished pool height should be elevated 24 inches above the surrounding grade to allow for a daylight drain. Even a very long daylight drain run is better than any other drainage method. Draining to whole property storm-water detention systems is also acceptable. The minimum drain diameter is three inches, but size and number of drains should increase with the pool size.

If it is not possible to drain to “daylight”, an adequately sized dry-well or pump out pit must be used. DO NOT use “french drains” where the drain end is buried in a hole with gravel. These types of drains typically fail within a year. Soil may have poor drainage or become saturated in heavy rains. Even the largest gravel pit will not work when silt and debris clog the end of the drain. An accessible dry-well can be cleaned out and accommodate a sump pump. If the cover housing will also function as an overflow drain, it must be able to handle a forgotten hose or rainfall for the whole pool.

Daylight or Open Air Drain



Dry-Well Drain



Exterior Spas

Raised Spa
 with spillway into pool
 *water feature shut-off controller recommended

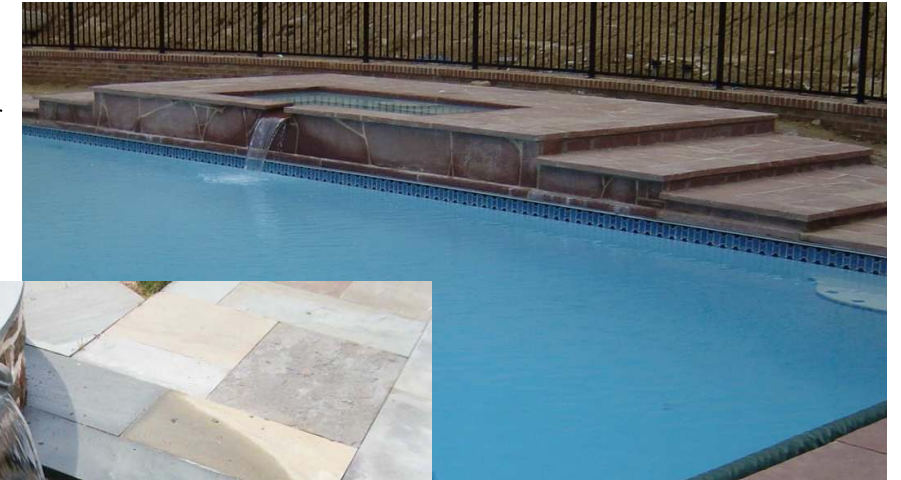

Raised Spa
 with catch pool
 and bridged coping

Open Spillway
 Used only on end wall spas



Bridged Spillway

Interior Spas



Centered Square



Full Width



Centered Round

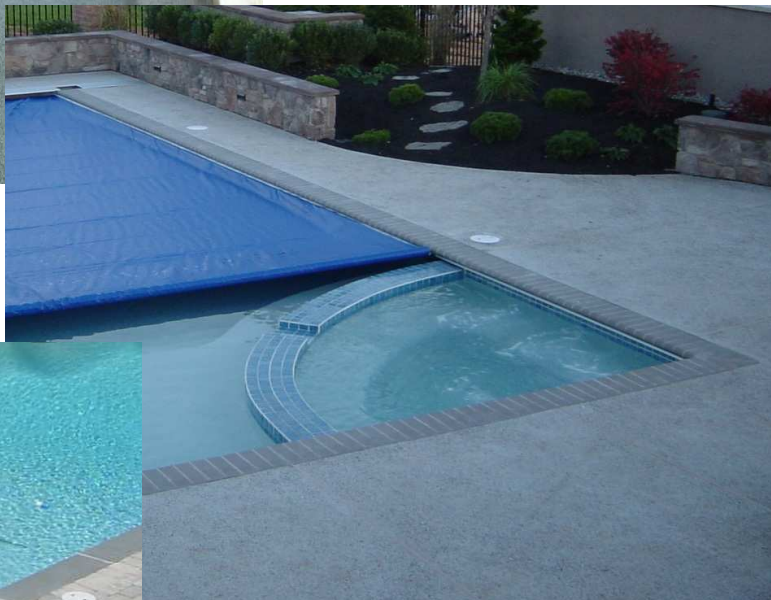

Corner Round



Corner Square

Automatic Autocovers for Pools with Raised Walls

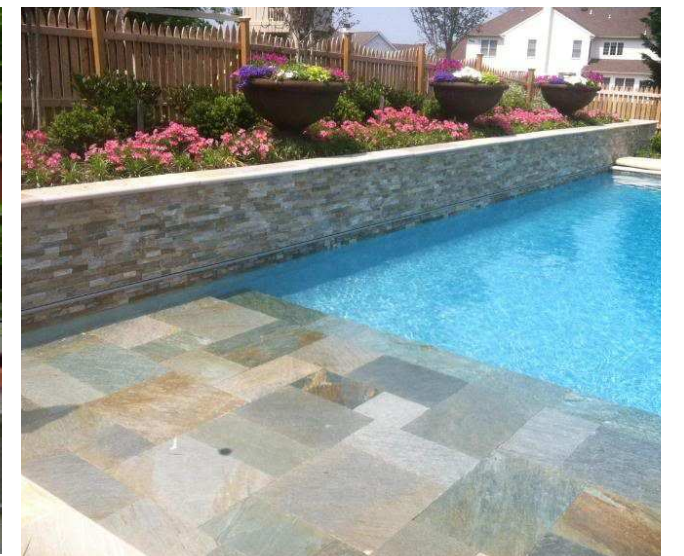

Autocovers for Pools with Raised Walls (continued)



Vertical Negative Edge

**Autocovers
for Pools with
a Vanishing Edge**

The Vanishing Edge pool is created by flowing water over one or more walls on the pool. These walls are lower and also sloped into the pool or away from the pool. If the vanishing edge is on the end of the pool where neither the autocover tracks or cover housing are located, there are no special requirements for the autocover system. If the vanishing edge is on the long side of the pool where the track is located, the pool will need to be carefully crafted and the autocover system created for the specific vanishing edge type.

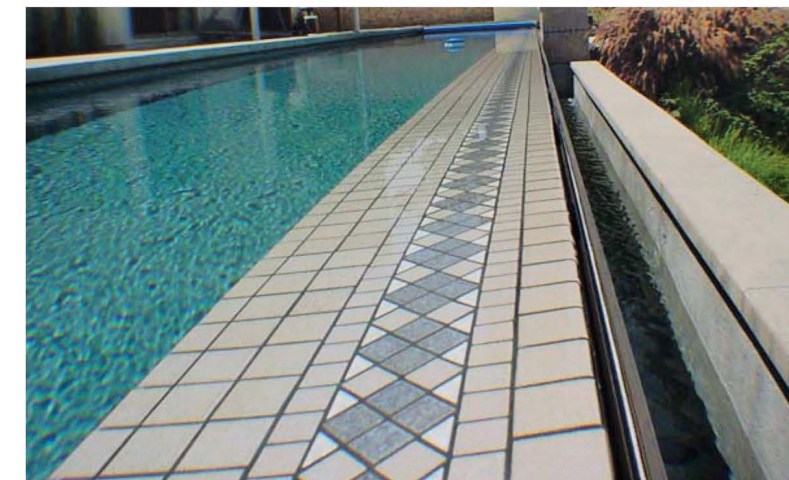

Autocovers for Pools with a Vanishing Edge

Sloped Negative Edge

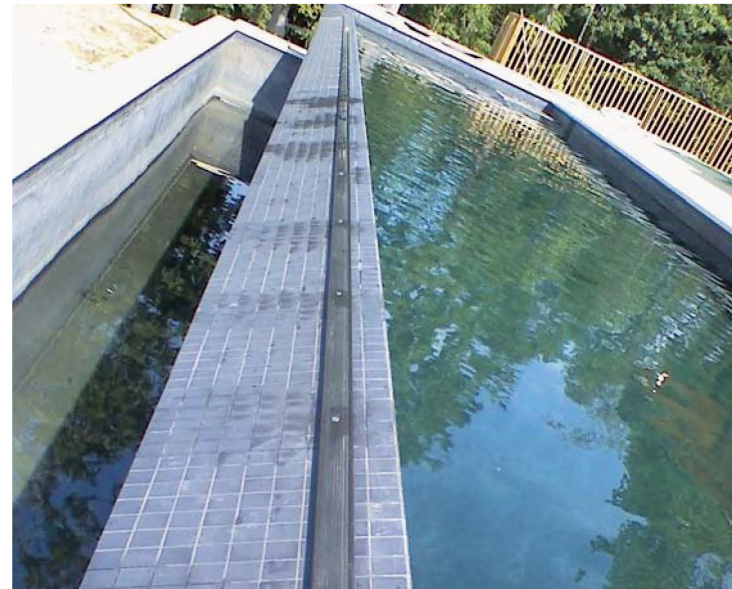

Autocovers for Pools with a Vanishing Edge

Vanishing Edge

