

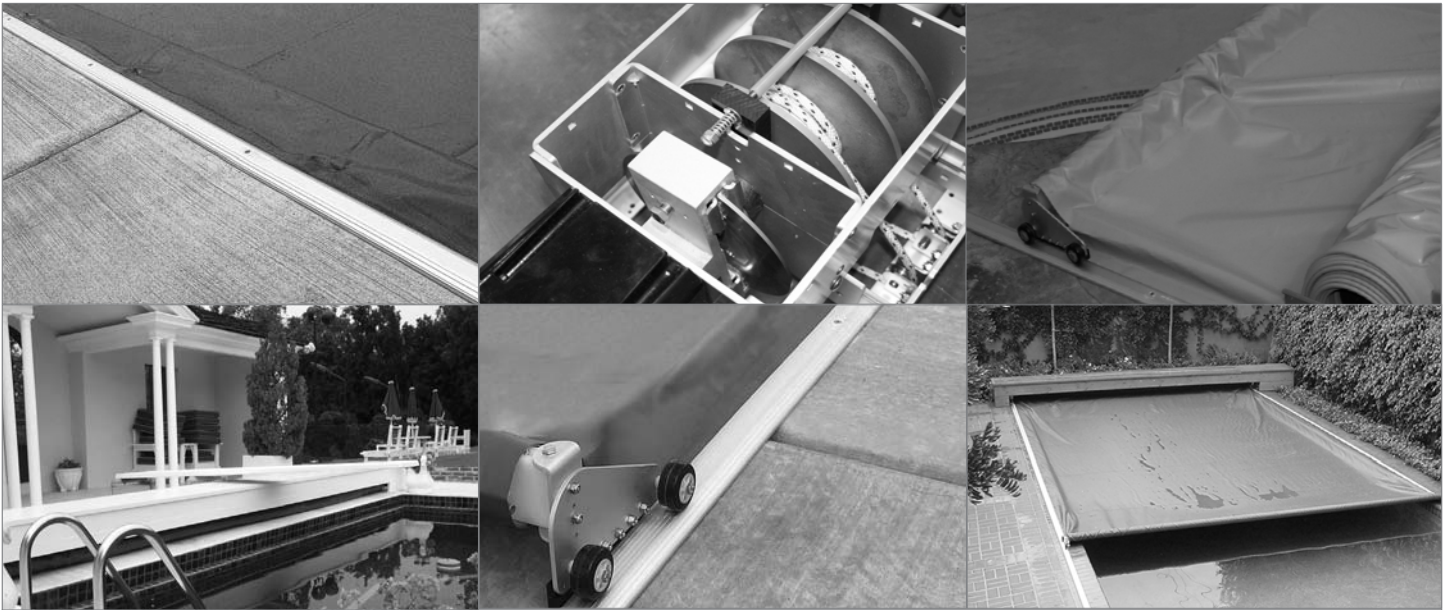

CS1800 AUTOMATIC SAFETY POOL COVER  
DECK MOUNT SYSTEM

INSTALLATION GUIDE



## SECTIONS

System Parts Reference .....	3
Standard Top Track.....	4-6
Mechanism .....	7-10
Cover Fabric.....	11-16
Home Owner & Builder Installation Checklist.....	17-18

### Tools Required

- |   |   |
|---|---|
| 1. Hammer drill or rotary hammer                  | 18. Crescent wrench                             |
| 2. Masonry drill bit 1/4" x 6" (1/4" x 12" bit)   | 19. 100 & 25 foot tape measure                  |
| 3. Extension cords                                | 20. Chalk line ( use white chalk)               |
| 4. #2 and #3 Phillips & standard screw drivers    | 21. Nut drivers - 5/16", 3/8", 7/16", 1/2"      |
| 5. Ratchet with 5/16" - 3/4" sockets              | 22. Chisel (wood & concrete)                    |
| 6. Hacksaw  | 23. Scissors                                    |
| 7. String line                                    | 24. Wire strippers                              |
| 8. Utility knife                                  | 25. Set of box/open end wrenches - 5/16" - 3/4" |
| 9. Broom  | 26. 6" level                                    |
| 10. Hammer & rubber mallet                        | 27. Set of allen wrenches                       |
| 11. Pliers - standard, needle nose & channel lock | 28. Wire  |
| 12. Files - round, triangular & flat              | 29. Electrical tape                             |
| 13. Lighter                                       | 30. Small sledge hammer                         |
| 14. Carpenter's square                            | 31. Vice grips                                  |
| 15. 5/16 hex head driver bit with 12" extension   | 32. #2 #3 Phillips drill bits                   |
| 16. Drill (cordless or corded)                    | 33. Pencil or marker                            |
| 17. Set of drill bits (1/4" down to 1/16")        | 34. 6 - 8 clamps                                |

### Optional Power tools

Skill saw with carbide tipped blade  
Sawzall, Grinder.

Mechanism Components Cover Fabric

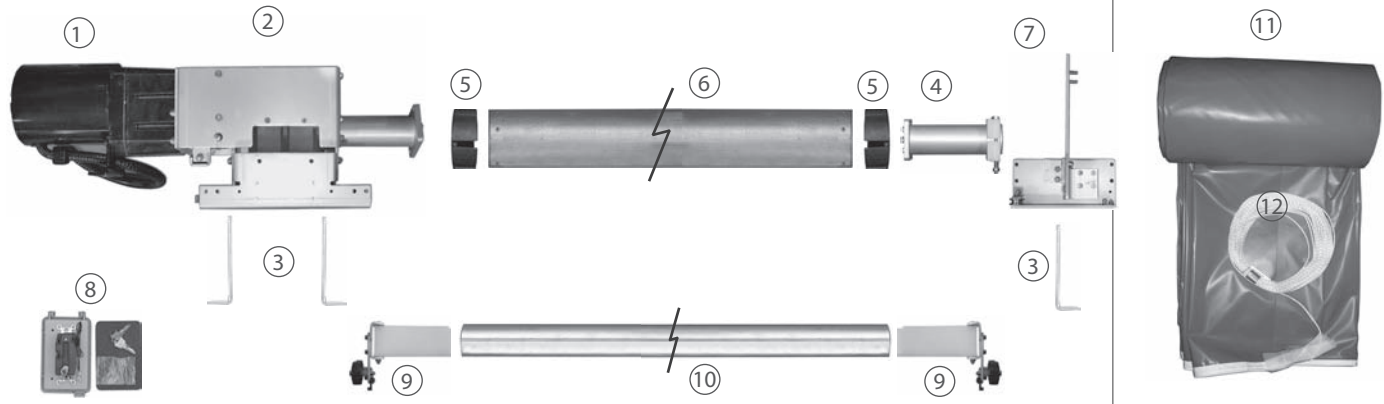

Cover Track Types Wheel Assemblies Cover Pump Guide Feed End Pulley



Parts List Misc. Hardware

- |   |  |
|---|--|
| <ul style="list-style-type: none"> <li>1. A0610 Motor &amp; housing, standard 3 wire Bison motor</li> <li>2. A0329 Mechanism Deck (Right)</li> <li>A0328 Mechanism Deck (left)</li> <li>3. M0305 Mechanism Mounting Foot</li> <li>4. A0020 Non-motor end cone assembly</li> <li>5. A0797 Tube insert for 6" tube</li> <li>6. X0001 6" aluminum roll-up tube</li> <li>7. A0412 Non-motor end assembly Deck (Right)</li> <li>A0141 Non-motor end assembly Deck(Left)</li> <li>8. A0605 Keyswitch-Leviton assembly complete w/light</li> <li>9. A1565 Wheel Assembly (standard top track)</li> <li>10. X0021 Aluminum leading edge</li> <li>11. Cover fabric</li> <li>12. Varies PowerFlex Rope - Lengths will vary by cover length</li> <li>13. X0656 Standard Top Track</li> <li>14. E1130 Little Giant cover pump &amp; instructions</li> <li>15. A1071 Guide feed for standard top track</li> <li>16. A0886 Pulley End (standard top track)</li> <li>17. E1098 Bonding wire</li> <li>18. E1086 Bonding lug ka-6u (for 1 wire)</li> <li>19. H0334 Screw PFSM 12 x 1-3/4 for Top track</li> <li>20. H0332 Screw PPSM 12 x 1-3/4 for lid hinge</li> <li>21. H0152 Screw PPMS 10-32 x 1/2</li> <li>22. H0176 Nut nylock 10-32</li> <li>23. H0075 Rope loop (black plastic)</li> <li>24. H0310 Screw PPSM 10 x 1/2</li> </ul> | <ul style="list-style-type: none"> <li>25. H0324 Plastic anchor STD #12</li> <li>26. H0331 Screw HHWSM Tek 10 x 1/2 SS</li> <li>27. H0096 Carriage bolt 1/4-20 x 1/2 SS</li> <li>28. H0006 Washer split lock</li> <li>29. M0105 Standard splice, top track</li> <li>30. H9630 Spring pin for track alignment</li> <li>31. H0276 Nylock nut 1/4 - 20</li> <li>32. H1101 Screw 10- 32 1-3/8"</li> <li>33. M9797 Stop Top track 403, L Shaped SS</li> <li>34. H0096 Bolt 3/8-16- 1-1/4</li> <li>35. H0331 Screw HHWSM 12 x 1-1/2 w/slot</li> <li>36. A1972 Electrical Junction Box with adapters</li> <li>37. A0113 Cover Roller &amp; Bracket</li> </ul> |
|---|--|



The parts list at above is typical for most pools up to 20' x 40' and includes all parts necessary to install the Coverstar system, however, parts will vary for longer or wider pools and according to your specific order.

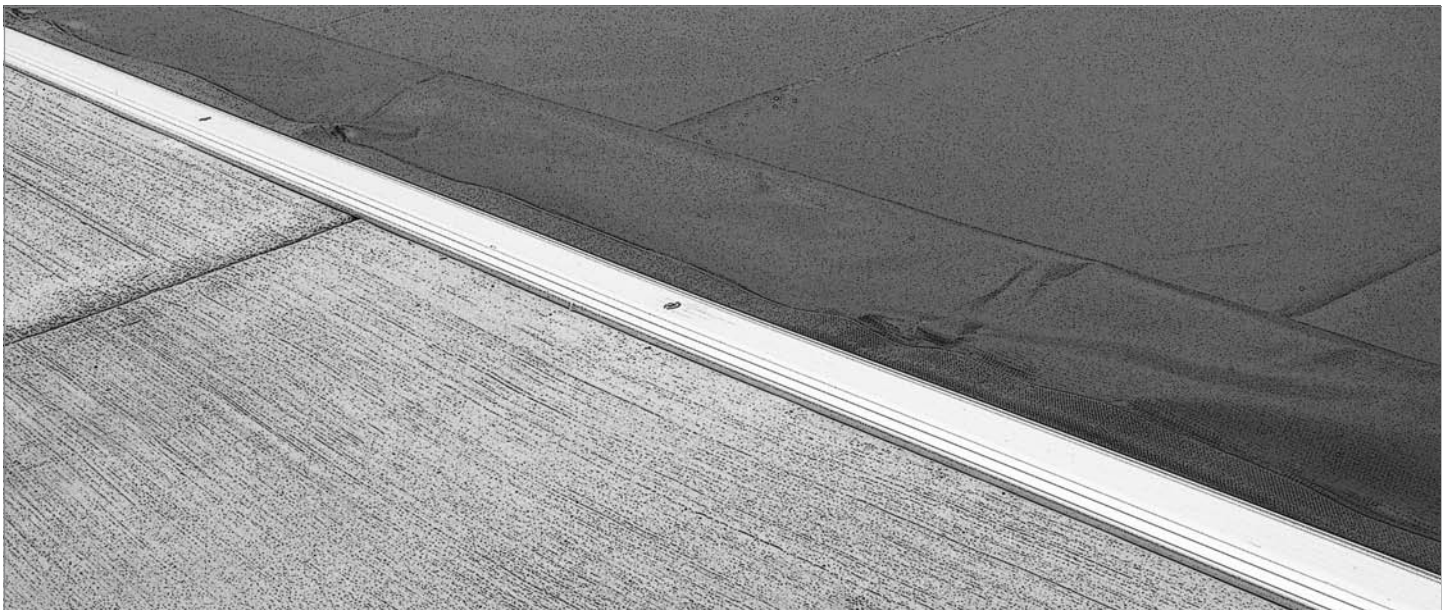

## STANDARD TOP TRACK

Step By Step Instructions	Page/Step
Laying out the cover tracks.....	5/2
Splicing the tracks together.....	5/4
Cutting the tracks to length .....	5/9
Checking for square .....	6/12
Attaching the tracks to the deck.....	6/14

## Step By Step Instructions

Numbers in parenthesis refer to hardware on page 3.

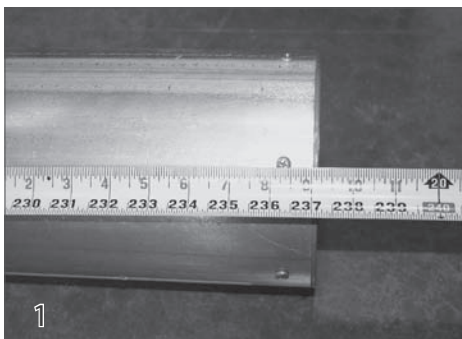

1  
To determine if the cover system was ordered correctly for the pool, the length of the roll-up tube should be 3 inches shorter than the track space. For example, the roll-up tube shown above measures 19 ft 9 inches. The correct track space is 20 ft.



2  
**Laying Out the Cover Tracks**  
Lay the cover tracks on the deck on both sides of the pool. When positioning the tracks, there needs to be at least 7" of clearance from the top of the finished deck to the bottom side of slides, ladders and hand rails for the wheel assemblies and leading edge to pass under without damaging the cover system.

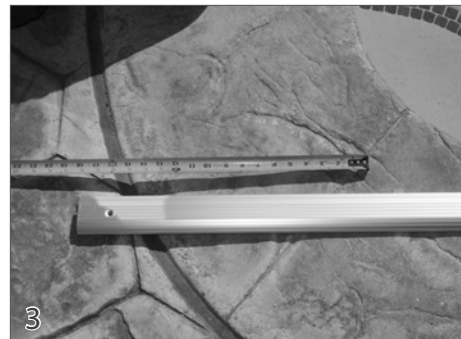

3  
Extend the tracks 18" past waterline. Center the pool shape between the pool tracks where possible. Measure and mark the track length on the deck. Use a chalk line to mark the track location.



4  
**Splicing the Tracks Together**  
Before splicing the sections of track together, file all track ends thoroughly, rounding all edges and removing all burrs. This step is extremely important. The cover can be damaged very easily by metal burrs and this damage is not covered by the warranty.



5  
Tap the spring pin (30) into the round splice channel. Slide the center splice (29) into the center channel.

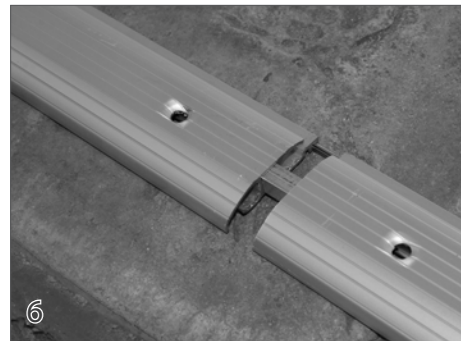

6  
Join the track sections together by hand.

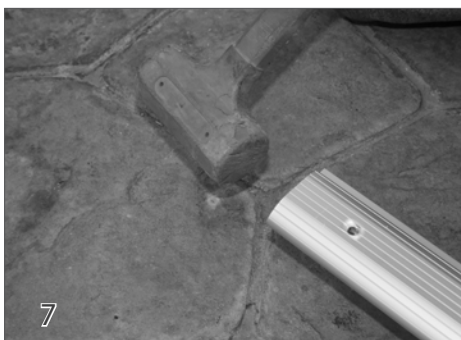

7  
At one end, use a rubber mallet to tap the track sections together.



8  
The two sections of track should be tight together.



9  
**Cutting the Tracks to Length**  
With tracks extended at least 18" past the waterline at the opposite end of the pool, cut the tracks so they extend 18" past the waterline at the mechanism end.

## Step By Step Instructions

Numbers in parenthesis refer to hardware on page 3.



10 Cut the track at the mechanism end to the proper length using a miter saw. It is important to have square cuts on the track. Note: Always wear safety goggles when using powered equipment.



11 File the track ends on both sides of the pool making sure to round all edges and remove all burrs. This step is extremely important. The cover can be damaged very easily by metal burrs and this damage is not covered by the warranty.



### Checking for Square

12 Measure the track space, track length and diagonals to make sure the tracks form a perfect square.

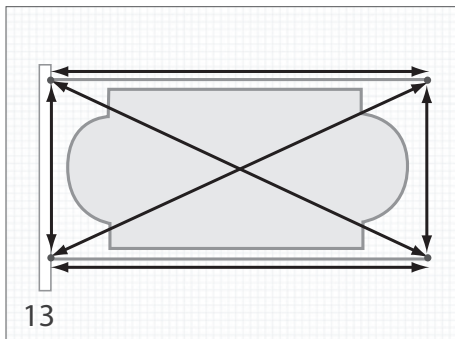

13 Lengths, widths and diagonal dimensions must be equal to each other or the system will not operate properly.



14 **Attaching the tracks to the Deck**  
Place the tracks into position on the deck in the marked positions. Make sure that the tracks run completely straight on both sides of the pool. Drill through the pre-drilled holes into the deck. Drill at least 3" deep.

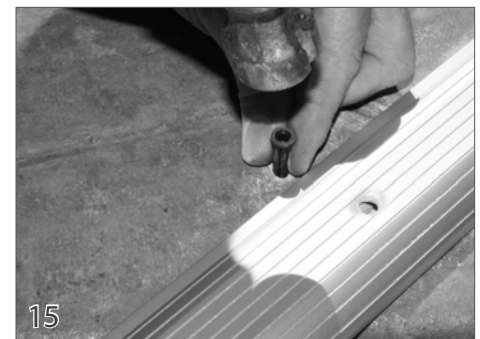

15 Move the tracks to the side to expose the holes in the deck. Tap the plastic anchors (25) into each hole.



16 Place the track back over the holes in the deck. Fasten the track screws (19) halfway through the tracks into the plastic anchors. The screws will be fastened completely later in the installation.

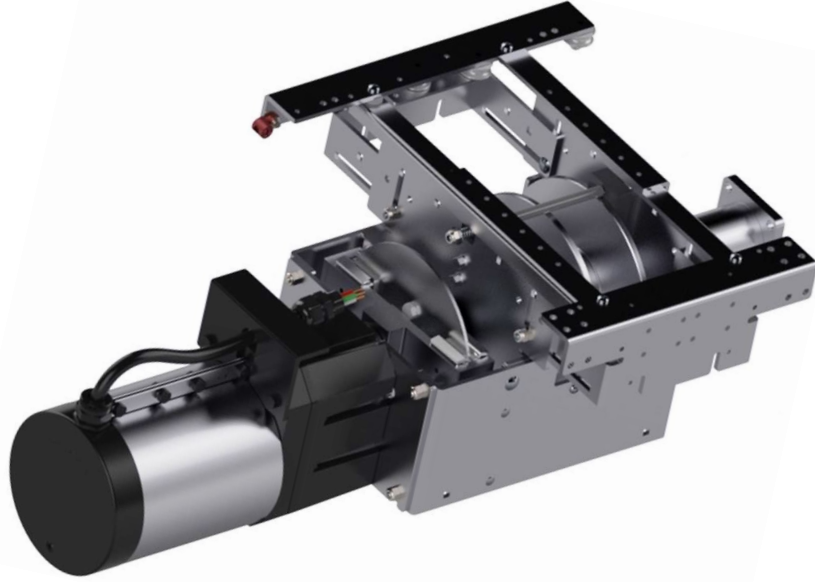

## MECHANISM

Step By Step Instructions	Page/Step
Attaching the roll-up tube .....	8/3
Positioning the roll-up tube/mechanism.....	8/5
Extending the Pulley brackets .....	8/6
Anchoring the mechanism .....	9/14
Wiring the electrical switch.....	10

## Step By Step Instructions

Numbers in parenthesis refer to hardware on page 3.

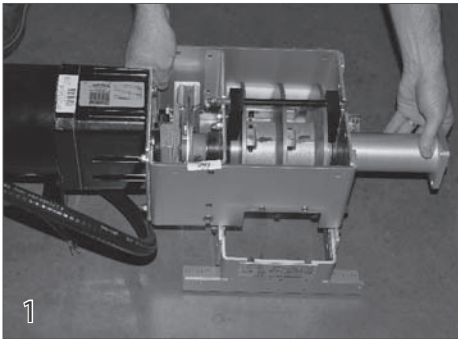

1  
Position the motor end of the mechanism roughly in the position that it will be mounted.

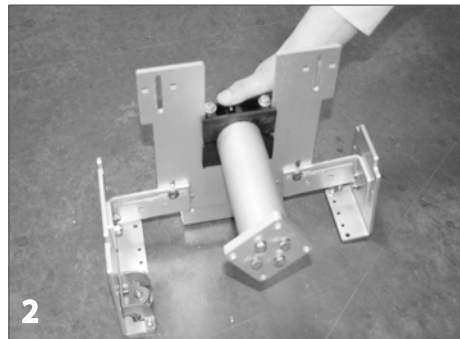

2  
Position the non-motor end of the mechanism roughly in the position that it will be mounted.

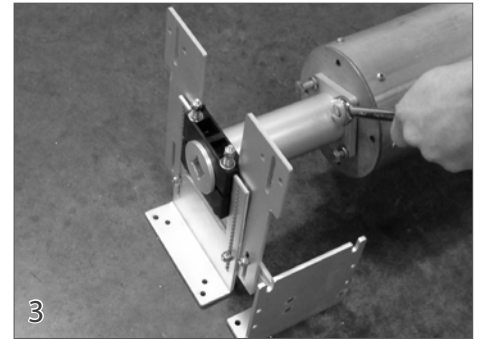

### Attaching the Roll-up Tube

With the non-motor end turned upside down, attach the cone for the non-motor end to the roll-up tube using the 3/8" x 1-1/4" bolts (34) and lock washers (28) provided.

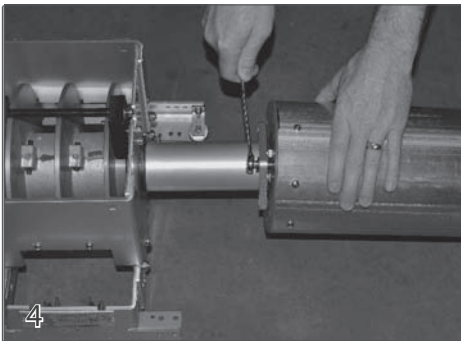

4  
With the motor end turned upside down, attach the cone on the motor end using the same bolts (34) and washers (28). Tighten the bolts using a 9/16" wrench.

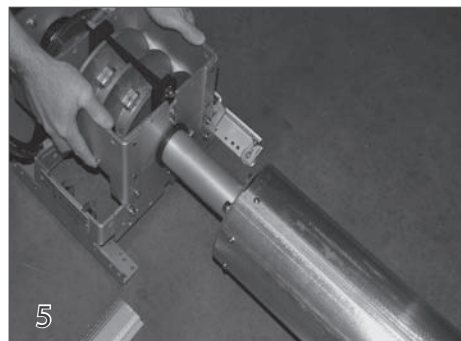

### Positioning the Mechanism

Place the mechanism on the pool deck roughly in the position that it will be anchored.

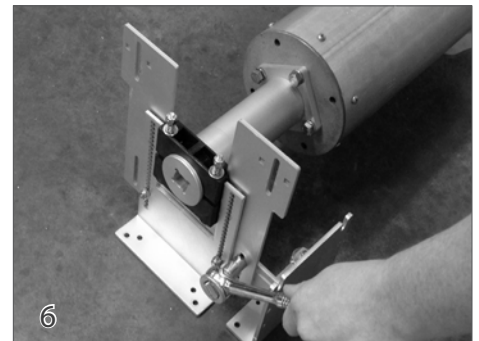

### Extend the Pulley Brackets

Use a 7/16" wrench to loosen the nylock nuts on the adjustable brackets of the mechanism.

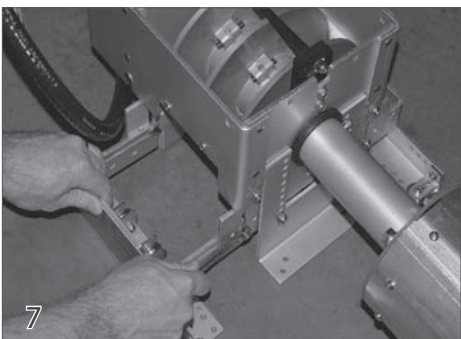

7  
Install the mounting feet on the motor end and non-motor end of the mechanism. The height of the mounting feet and the pulley brackets can be adjusted based on the length of the cover to prevent the cover from rubbing on the deck.

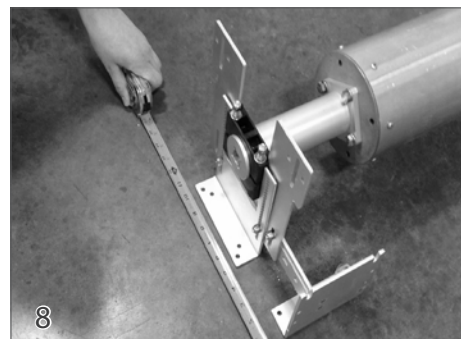

8  
Adjust the position of the pulley brackets to spread the brackets wider to stabilize the system.



9  
With the mechanism and tube assembled, check the roll-up tube for level. If the deck isn't level, the distance from the deck to the tube should be the same on both ends of the tube.

This is crucial for a properly operating cover. Adjust the non-motor end as needed to level the roll-up tube.



## Step By Step Instructions

Numbers in parenthesis refer to hardware on page 3.

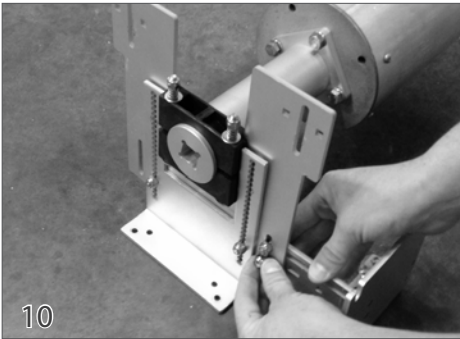

Use a 7/16" wrench to tighten the nylock nuts. Additional carriage bolts (27) and nylock nuts (31) are provided and can be used as reinforcement for the pulley brackets if needed.

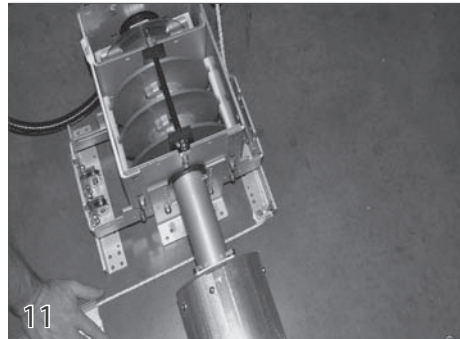

Align the mechanism on the motor side first by using a piece of rope. Extend it from the outside channel of the track to the pulley to make sure the rope will feed directly into the pulley.

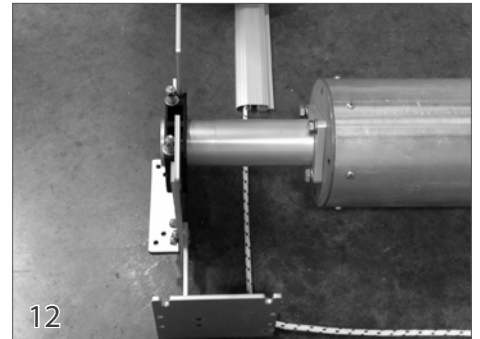

Go to the non-motor end and make sure the rope will come straight back from the rope channel of the track to the pulley. If the ropes do not come straight back, the mechanism should be moved to balance the rope angle on both sides. Only a 1/2" variance from straight is allowed on either side.

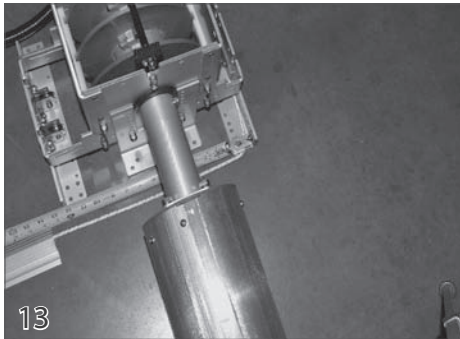

On both the motor end and non-motor end of the mechanism, measure from the cover track to the pulley. It is important that the mechanism be mounted square to the cover track.

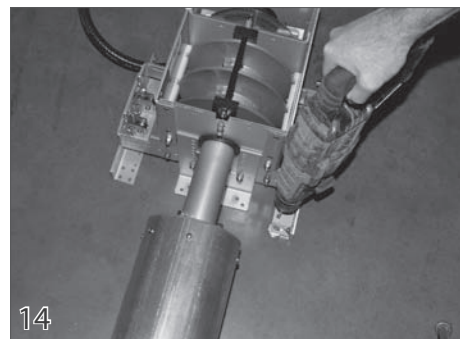

### Anchoring the Mechanism

Use a 1/4" bit and hammer drill to drill through the mounting holes in the mechanism into the deck.

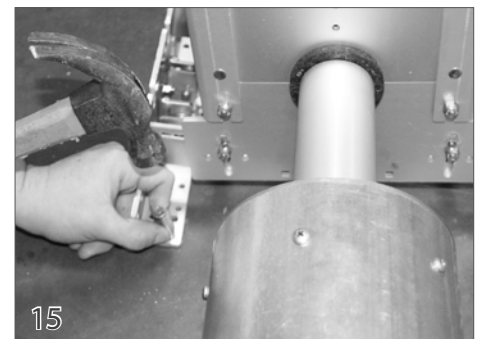

Use the 1-1/2" hex head screws (35) and anchors (25) provided to secure the motor end and non-motor end to the deck.

## Electrical Wiring and Bonding

The automatic cover system must be bonded to meet the National Electrical Code. Bond both tracks to the mechanism by attaching a bonding lug to the guide feed screw and running a #8 solid copper bond wire to the mechanism.

Bond the lid to the mechanism by drilling a hole in the lid at either end and attaching a bonding lug. Run bond wire from this lug to the mechanism.

All brackets and any other metal over 4" long should likewise be bonded to the mechanism. There should be a bond wire extended from the equipment pad to the cover box, so it too can be attached to the mechanism.

Note: Builder is responsible to bring proper electrical lines, conduit and bonding to the mechanism. Electrical wiring diagram and details are shown below.

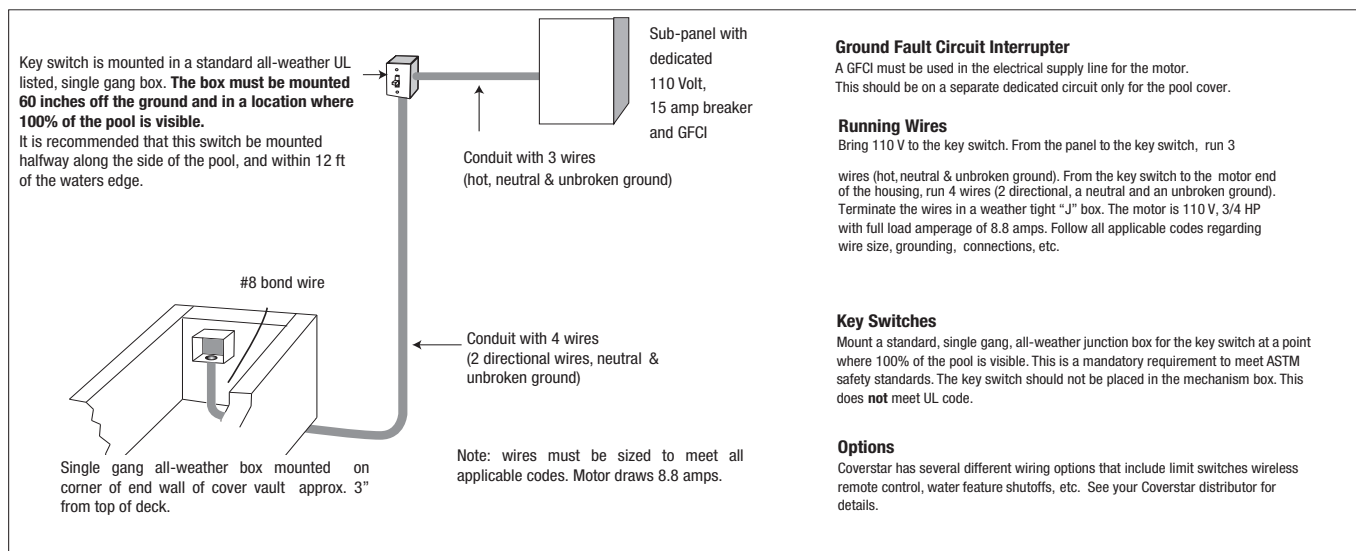

## Wiring the Electrical Switch

The control switch must be mounted in an all-weather box, in a location where 100% of the pool is visible. Connect the control switch according to the diagram below.

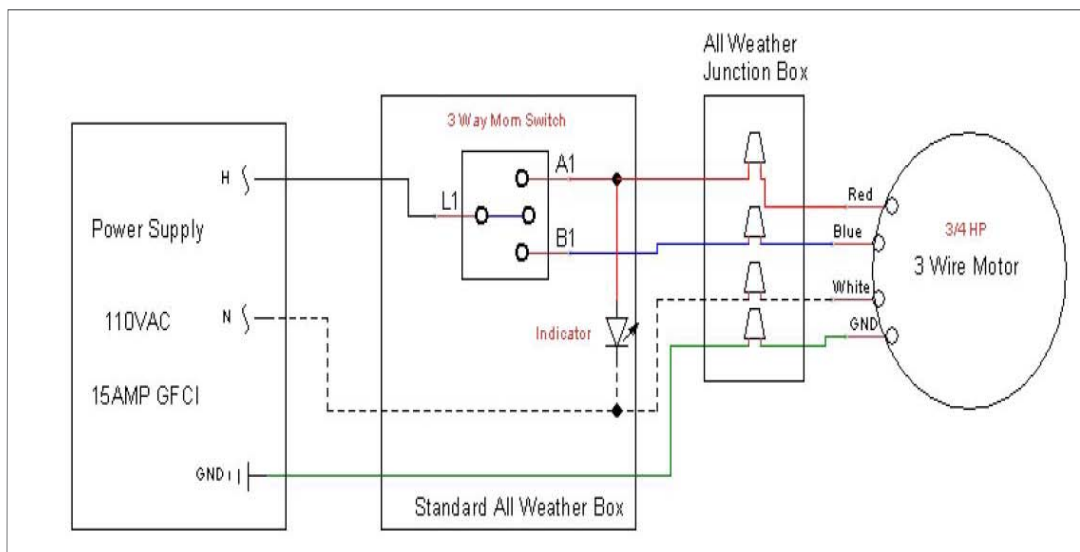



## COVER FABRIC

Step by Step Instructions	Page/Step
Opening the cover .....	12/1
Unrolling the cover .....	12/2
Running ropes through the tracks .....	12/3
Routing the ropes.....	12/9
Attaching the cover leading edge .....	13/15
Attaching the ropes to the rope reel .....	15/28
Running the cover over the pool.....	15/30
Attaching the cover and bonding wire .....	15/31
Adjusting the ropes .....	15/35
Adjusting the torque limiter .....	16/38
Adjusting the brakes .....	16/40

## Step By Step Instructions

Numbers in parenthesis refer to hardware on page 3.

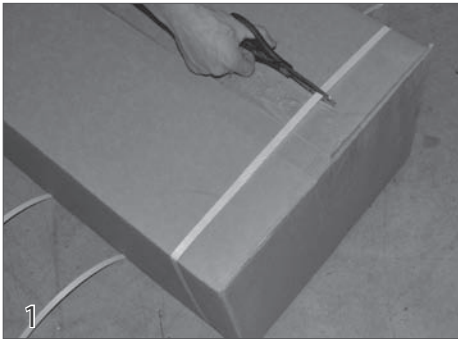

### Opening the Cover

To open the cover box, cut the bands that hold the two halves of the box together. Never cut the top of the box open. Doing this could easily damage the cover inside. This kind of damage is not covered under the fabric warranty. With the bands cut, lift and remove the top box.



### Unrolling the Cover

Standing behind the housing looking over the pool, unroll the cover from left to right.



### Running Ropes Through the Tracks

The preferred method of running the rope is to pierce the rope with a 1' length of wire and use it as a handle to feed the rope through the track.

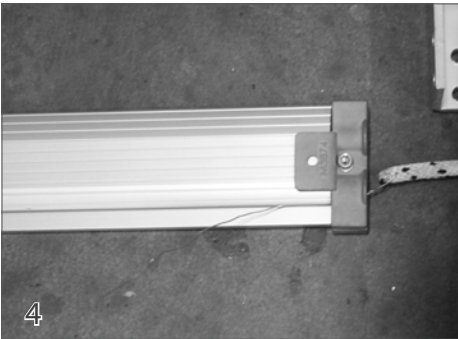

Feed the rope into the water side channel of the track with the wire extending out the side of the track. Use the wire to pull the rope down the length of the track towards the end of the pool.

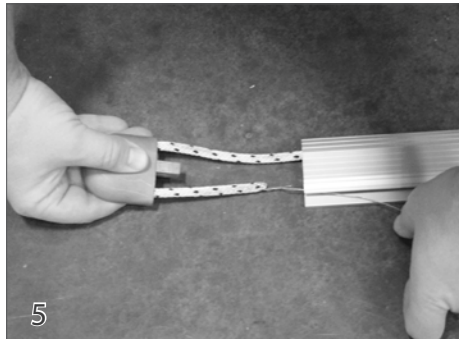

Feed the rope through the end pulley assembly (16) and insert the pulley housing into the end of the track.



Feed the rope into the back channel of the track, then pull the rope down the back side of the track toward the cover housing.

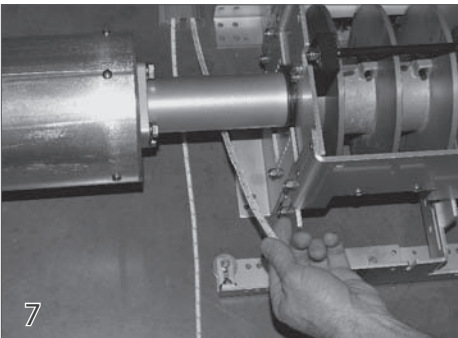

Pull all excess rope through the cover track.



Complete the fastening of all track screws flush to the top of the track. Clean concrete dust from track and pulley end cap. Make sure ALL screws are flush with the top of the tracks.

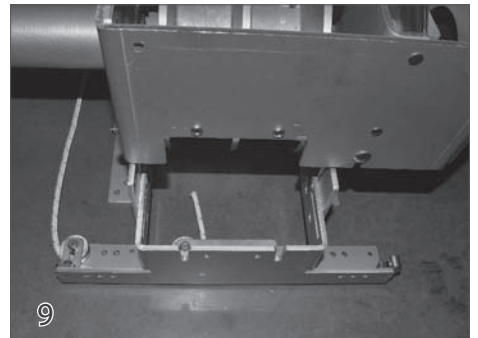

### Routing the Ropes

Begin with the rope on the motor end. Feed the wire that is attached to the rope around the first and second pulleys.

## Step By Step Instructions

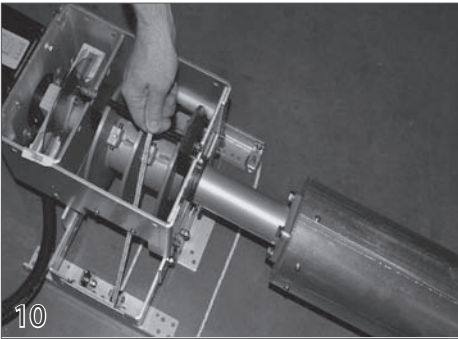

10  
Direct this rope over the rope reel, under the rope containment bracket and out of the mechanism.

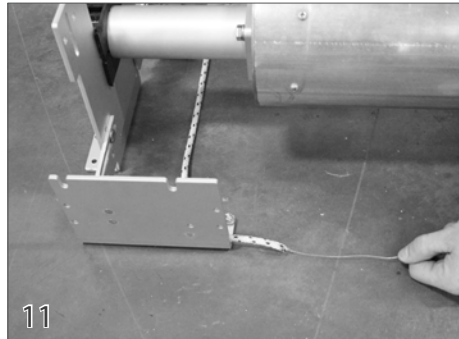

11  
On the non-motor end, feed the wire that is attached to the rope around the pulley and out the back channel of the pulley assembly. Pull this rope to the motor end pulley assembly.

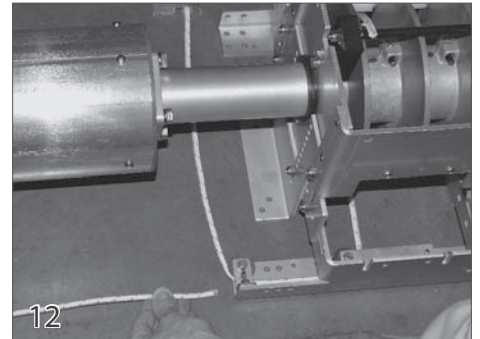

12  
Insert the wire that is attached to the rope into the channel behind the first pulley. Continue to push the wire until it comes out of the channel behind the third pulley.

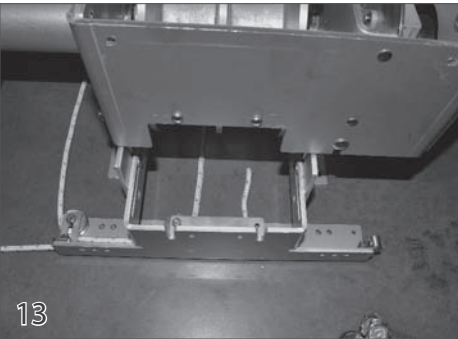

13  
Bend a curve into the end of the wire and pull it back just until it is in the middle of the pulley. Now push the wire back until it comes out along the side of the third pulley.

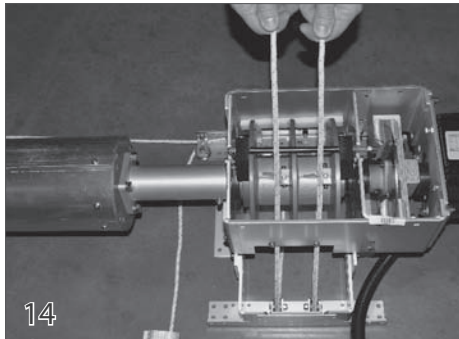

14  
Pull the rope over the rope reel, under the rope containment bracket and out of the mechanism.



15  
**Attaching the Cover Leading Edge**  
Lay the front of the cover in front of the mechanism. Slide the leading edge through the loop on the front of the cover.



16  
Attach the detachable rope tab to the three hole plate on the wheel assembly.

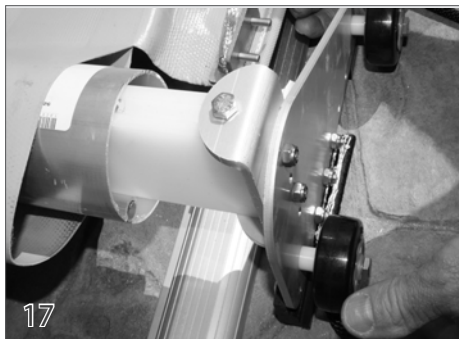

17  
Place the nylon leading edge inserts into the ends of the leading edge tube. Make sure they can slide freely inside the leading edge tube.

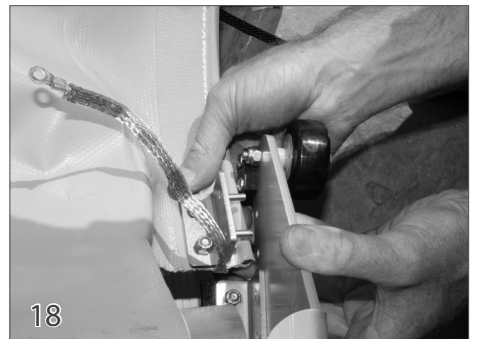

18  
Connect the two hole bracket that is attached to the front corners of the cover to the wheel assemblies.

## Step By Step Instructions

Numbers in parenthesis refer to hardware on page 3.

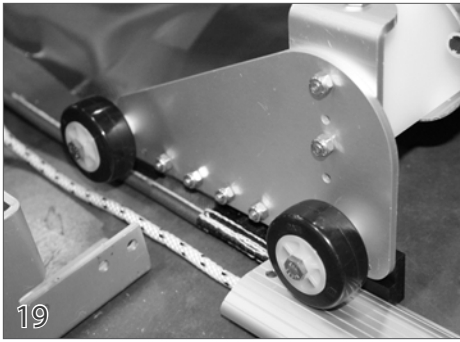

19 Feed the wheel assembly and cover into the track.

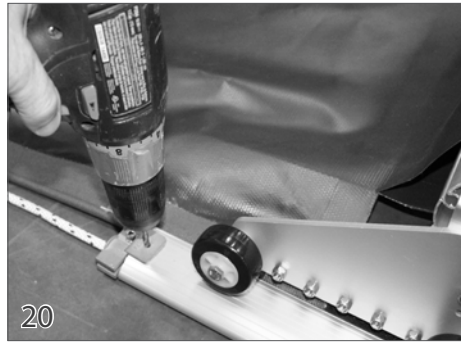

20 Place a guide feed (15) over the end of the track and drill  $3/16$  hole through the hole in the guide feed and through the track.

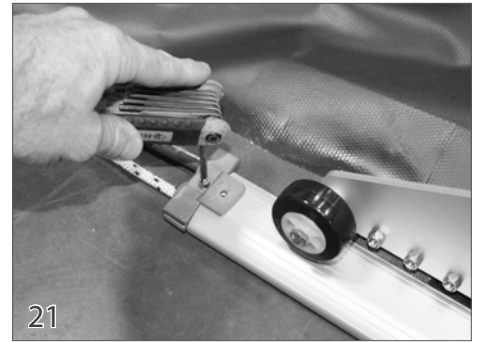

21 Use a  $5/32$  allen wrench to tighten the screw that connects the two sections of guide feed together.



22 Install a stop on the end of the track near the mechanism to keep the cover from retracting too far. Secure the stop to the deck using the screws (19) and anchors (25) provided. Run the key switch in the uncover position to roll the cover up on the roll-up tube. Check the cover to be sure it rolls up evenly.

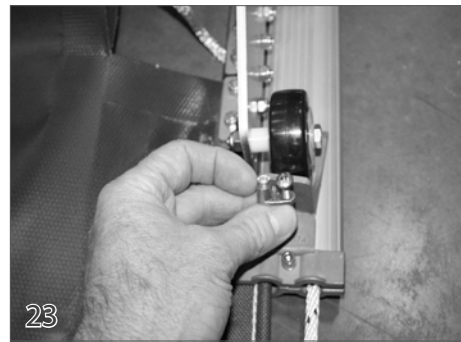

23 Place a bonding lug (18) on top of the guide feed. Insert a 10-32 x 1-5/8 screw (32) through the lug, guide feed, and track. Install a 10-32 nylock nut (22) and tighten with a  $3/8$ " wrench.

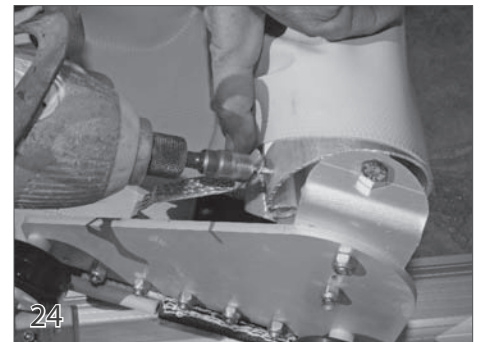

24 Connect the bonding wire that is attached to the front corner of the cover to the leading edge bar using a tek screw (26). Be sure the screw doesn't interfere with the leading edge insert.



25 Position the fabric on the leading edge so it is in line with the leading edge support bracket. Secure with a tek screw (26) on the back side of the leading edge. Be sure the screw does not interfere with the leading edge insert.

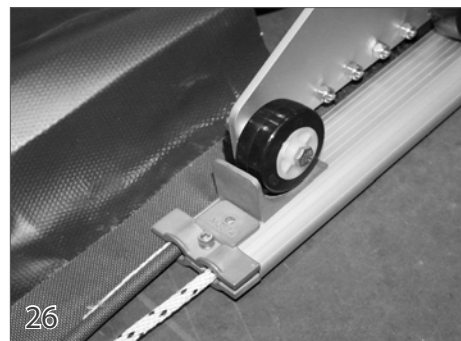

26 Pull the cover back until the cover is in the track equally on both sides. Pull the ropes tight as they come off the pulleys on the mechanism to eliminate the slack in the rope.



27 Pull both ropes until the leading edge just moves on each side, cut the longer rope to the same length as the shorter rope while tight. These ropes should be at least 8 ft long. Use a lighter or torch to burn the ends of the rope. In most cases you will only need to cut one rope.

## Step By Step Instructions

Numbers in parenthesis refer to hardware on page 3.

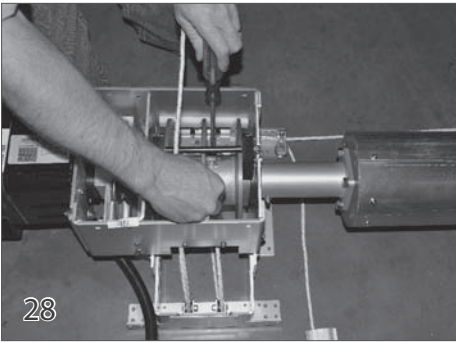

**Attaching The Ropes to the Rope Reel**  
Loosen the set screw and remove plastic plug from the rope holder tube. Bring the ropes back to the mechanism. Attach the ropes to the rope reel by inserting the ropes through the center of the rope holding tube and tighten the set screws firmly into the ropes. Some prefer to tie a knot at the end of the rope.



While holding the ropes over the mechanism, run the key switch in the cover position. The excess rope will be wrapped around the rope reel.



**Running The Cover Over the Pool**  
Run the cover over the pool being careful to prevent it from binding in the guide feeds by lifting the cover and helping it into each track the first time.



**Attaching the Cover & Bonding Wire**  
At the motor end, attach the tail of the cover and the bonding wire to the roll-up tube using 1/2" tek screws (26). Make sure the webbing continues straight as it travels from the track to the roll-up tube. Attach the cover and bonding wire to the roll-up tube on the non-motor end in the same manner. Webbing should roll-up completely off the tube.



The first two screws need to be 3" from the end of the tube. Distribute the slack of the cover evenly across the length of the tube. Secure the cover to the roll-up tube using tek screws every 2-3 ft. When attaching the cover to the tube, do not use folds or pleats.

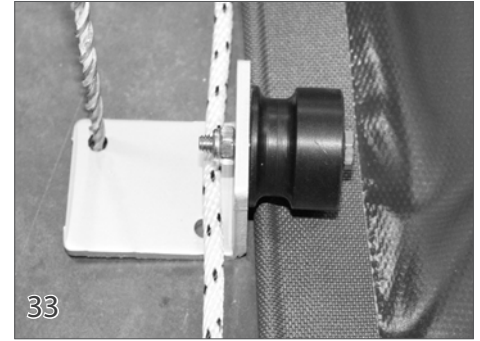

To help the cover roll up evenly, install a cover roller 2-3 inches behind the guide feed. Secure the cover roller to the deck using the screws (19) and anchors (25) provided.

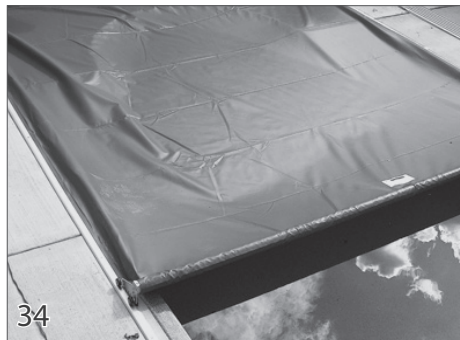

Run the key switch in the uncover position to roll the cover up on the roll-up tube. Check the cover to be sure it rolls up evenly. Run the cover 6-10 times to make sure it opens and closes evenly. The cover fabric installation is now complete.

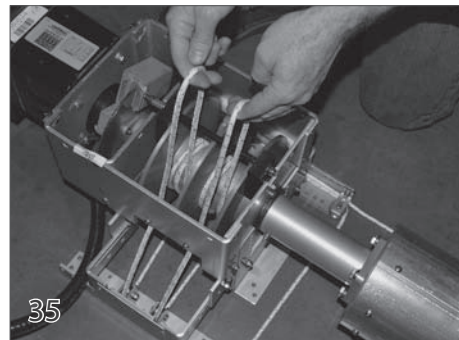

**Adjusting the Ropes**  
When closing the cover, if both sides of the cover don't close squarely, one of the ropes may need to be adjusted. To adjust the rope, open the cover all the way. Pull the excess rope off the rope reel.

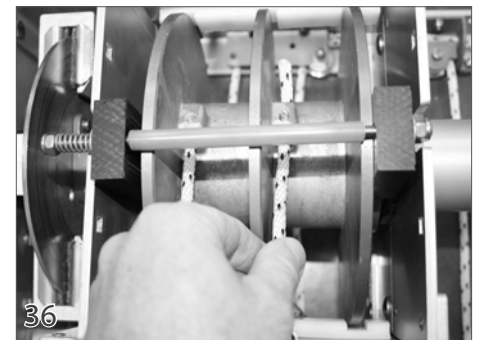

If one of the ropes is longer than the other rope, loosen the set screw that secures the rope to the rope reel lug. Shorten this rope until it is the same length as the other rope. Re-attach the rope to the rope reel.

## Step By Step Instructions

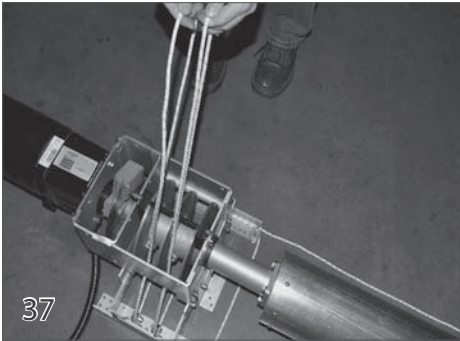

If both ropes are the same length, and the cover doesn't close squarely, shorten the rope for the side of the cover that doesn't close all the way. The amount that the rope is shortened is equal to the amount distance that the cover needed to travel to close all the way. While holding the rope, run the switch in the cover position.

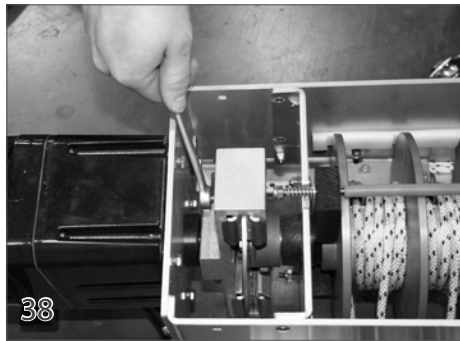

### Adjusting the Torque Limiter

The aluminum automatic cover system is equipped with a torque limiter that helps prevent damage to the mechanism. Only if the motorized mechanism does not extend or retract the cover will you need to adjust the torque limiter.

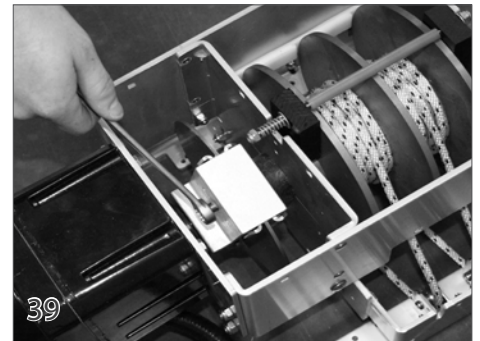

To adjust the torque limiter, use a 9/16" wrench to tighten the first torque limiter bolt 1/2 turn. Run the cover.

If further adjustment is needed, rotate the torque limiter brake arm to position the second brake bolt and tighten the second brake bolt 1/2 turn.

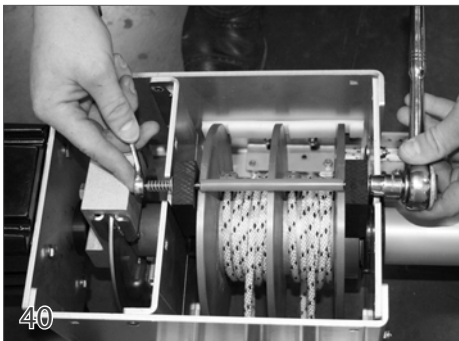

### Adjusting the Brakes

The mechanism is equipped with two brakes; one on the rope reel, and one for the roll-up tube of the mechanism. The brakes are preset at the factory and should work properly.

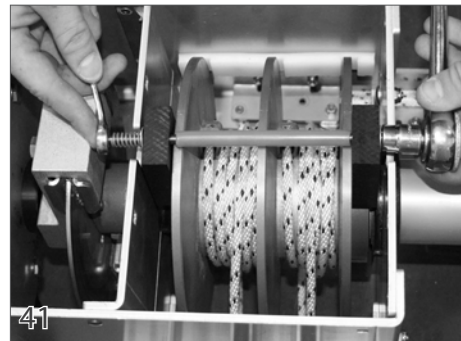

The rope reel brake should be tight enough to prevent the ropes from free spinning off the reel while the cover is opening. If you need to adjust the brakes, use two 7/16" wrenches or sockets to adjust the tension on the rope reel.

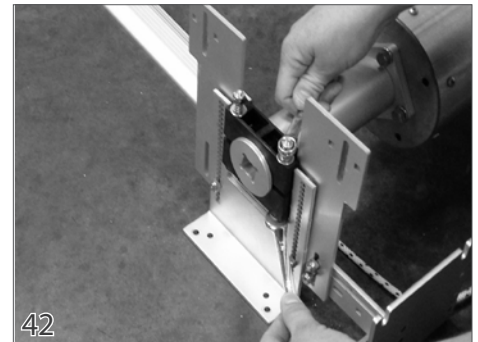

The roll-up tube brake should be tight enough to prevent the cover from rolling off the tube faster than it is being pulled into the tracks. To adjust this brake, use two 7/16" wrenches and tightening or loosening the thru bolts in the brake block.





## HOME OWNER CHECKLIST

After the cover system is installed, it is critically important to instruct the home owner on how to operate the cover system safely and do routine maintenance. Use the following check list and the ECLIPSE Use & Care Guide as your primary instruction source.

### Use & Care Guide Page

- How to use the cover pump .....4
- How to uncover and cover the pool .....6-7
- Warn about standing water on the cover .....4
- Who is authorized to operate the cover system.....6
- Pool chemicals and cover life .....8
- Proper maintenance and care of the cover system....8-9
- Inform the customer on pool safety .....Back cover

# Installation Check List

## Tracks

- Does the track space measurement match how the cover system was ordered?
- All track ends filed. This is extremely important.
- Cover goes through the track joints smoothly.
- All track screws are tight and flush.
- Pulleys are flush against the end of the track.
- The guide feeds are snug against the track.
- Guide feeds bolted in and are tight.
- Stops installed.
- Alignment pins and splices used when joining the tracks, even in encapsulation.

## Mechanism

- Mechanism installed level in the box.
- Roll-up tube level in cover box.
- Tube centered between the tracks.
- Enough clearance top, bottom, sides for the fabric. No rubbing of webbing on sides or bottom of box.
- Tube at the right height? The ideal location is to install the cover in the box so that the cover is coming off at as small an angle as possible. This reduces stress on the mechanism and reduces wear on cover tracks at the end of the track.
- Tube either centered in the box or positioned slightly more towards the back of the box, so that the cover is unlikely to rub on front of the box.
- System mounted at right angle to the track.
- Ropes coming back straight out of the track. An excessive angle will cause wear on the cover tracks at the end of the track.
- Ropes are not rubbing on any brackets or the deck.
- Ropes are run correctly.
- 8 feet of rope left on rope reel.
- System bonded according to electrical code. Cover bonded to leading edge and roll-up tube.
- Make sure there is adequate drainage from the cover box.

## Cover

- Fabric pinned to the roll-up tube without pinned folds.
- Cover runs smoothly.
- Cover properly aligned when it closes or retracts. Note: An inch or two out of square is not uncommon and is not a concern as it will not affect the operation of the cover. Because of the size of the fabric roll, and changes in operating conditions the cover may vary slightly in alignment as it is run.
- The leading edge inserts move in and out freely the whole length of the pool.
- Fabric is pinned to the leading edge flush with the ends of the tube.
- Cover not rubbing in the cover box as it rolls up.

## Cover Lid

- All sharp edges have been filed.
- All areas where the lid is not flat on the deck have been screwed down to eliminate any potential hazards.
- There is enough clearance between the lid brackets and the cover to avoid rubbing.

## Misc.

- Key switch is in full view of the pool.
- Cover pump tested by putting it in the water and operate it in front of homeowner.
- The cover box is clean and clear of debris so that the drains are not easily clogged.
- Pool area cleaned up.
- Homeowner has been instructed on the operation of the automatic safety cover system.



## QUESTIONS?

For questions about this installation guide,  
contact your independent Coverstar distributor.



Latham Pool Products  
787 Watervleit-Shaker Rd.  
Latham, NY 12110 USA